



E series tips



5 Racks per Pack Available!

We open to new ideas !

Catalog 2023

GenFollower.com

Add: NO.11, TENGDA ROAD, CAO'E STREET,
SHANGYU AREA, SHAOXING CITY, CHINA
Web: www.GenFollower.com
Email: GenFollower@GenFollower.com
Tel : +86-575-8293-6953
Fax: +86-575-8203-2762

SHAOXING GENFOLLOWER BIOTECH CO.,LTD.

CONTENTS

G2 PCR plates

01



G2 PCR strips

03



PCR tubes

04



Filter pipette tips

05



Racks for Tubes & Vials

31

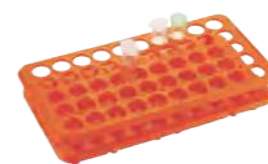

Petri dishes

32



Screw Cap Culture Tubes

33



Cell Scrapers,
Blades & Lifters

35



Pipette tips

09



Reagent Reservoirs

12



Rainin LTS

13



Robotic tips

15



Cell Spreaders

37

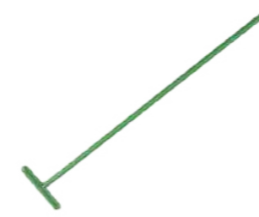

Inoculating
Loops & Needles

38

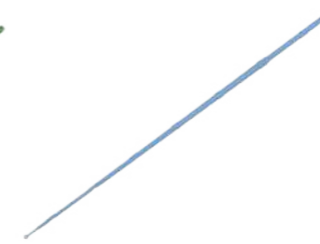

Serological pipettes

39



Pasteur pipettes

41



Deep well plates

23



ELISA plates

25



Centrifuge tubes

26



Micro centrifuge tubes

27



Screw cap micro tubes

42



Cryo tubes &
Cryo racks

46



Spin Columns

50



Laboratory Equipment

51



G2 PCR plates

· The G2 PCR consumables is the latest version of our PCR plastics. It stands for best level of us on injection molds.

· To ensure the result of your researchers, we tested more than 30 kinds of polypropylene, and chose the best one, the special polypropylene could help to fit blocks of cyclers from both PCR and (q)PCR.



ORDER INFORMATION

Size	Type	Color	Packaging	Cat.#	Quantity per Case	Size / Case (CM)			Weight / Case(Kg)
						L	W	H	
40uL	Full-Skirt	Nature	15 PCS/Box	A384FS-004N	10 Boxes (15 PCS/box, 10 Boxes/Case)	50	41.5	16.5	4
40uL	Full-Skirt	White	15 PCS/Box	A384FS-004W	10 Boxes (15 PCS/box, 10 Boxes/Case)	50	41.5	16.5	4
0.1mL	Non-Skirt	Nature	15 PCS/Box	B96NS-01N	10 Boxes (15 PCS/box, 10 Boxes/Case)	50	41.5	16.5	4
0.1mL	Non-Skirt	White	15 PCS/Box	B96NS-01W	10 Boxes (15 PCS/box, 10 Boxes/Case)	50	41.5	16.5	4
0.2mL	Non-Skirt	Nature	15 PCS/Box	B96NS-02N	10 Boxes (15 PCS/box, 10 Boxes/Case)	50	41.5	16.5	4.9
0.2mL	Non-Skirt	White	15 PCS/Box	B96NS-02W	10 Boxes (15 PCS/box, 10 Boxes/Case)	50	41.5	16.5	4.9
0.1mL	Half-Skirt	Nature	15 PCS/Box	B96HS-01N	10 Boxes (15 PCS/box, 10 Boxes/Case)	50	41.5	16.5	4
0.1mL	Half-Skirt	White	15 PCS/Box	B96HS-01W	10 Boxes (15 PCS/box, 10 Boxes/Case)	50	41.5	16.5	4
0.2mL	Half-Skirt	Nature	15 PCS/Box	B96HS-02N	10 Boxes (15 PCS/box, 10 Boxes/Case)	50	41.5	16.5	4.9
0.2mL	Half-Skirt	White	15 PCS/Box	B96HS-02W	10 Boxes (15 PCS/box, 10 Boxes/Case)	50	41.5	16.5	4.9
0.2mL	Half-Skirt	Nature	15 PCS/Box	A96WS-02N	10 Boxes (15 PCS/box, 10 Boxes/Case)	50	41.5	16.5	5.2
0.2mL	Half-Skirt	White	15 PCS/Box	A96WS-02W	10 Boxes (15 PCS/box, 10 Boxes/Case)	50	41.5	16.5	5.2
0.2mL	Half-Skirt	Nature	15 PCS/Box	A96WS-02PN	10 Boxes (15 PCS/box, 10 Boxes/Case)	50	41.5	16.5	5.2
0.2mL	Half-Skirt	Nature	15 PCS/Box	T96HS-02N	10 Boxes (15 PCS/box, 10 Boxes/Case)	50	41.5	16.5	5.2

Sealing films for plates

Class	Type	Color	Packaging	Cat.#	Quantity per bag
High transparent	Pressure-Sensitive	Transparent	100PCS/BOX	QPCR96F-1	100PCS/Box
Common	Self-Adhesive	Transparent	100PCS/BOX	PCR96F	100PCS/Box
Aluminum Sealing Films	Medical-grade Acrylic Adhesive	Non-permeable	100PCS/BOX	AF00001	100PCS/Box

· We would like to let you know our G2 PCR Plates and Strips are produced base on top quality standard.

· Now they could work up to 97% of current PCR machines around the world.

· Every plate is produced in the 100,000 level dust clean workshop, so it's DNase and RNase free, No human DNA, Non-pyrogenic.

· The improved polypropylene made the well transparent for easy observation. Especially, uniform thin wall to 0.30mm for optimal heat transfer.

· 3 Types: Non-skirt, Half-skirt and Full-skirt .

work up to
97%



G2 PCR strips

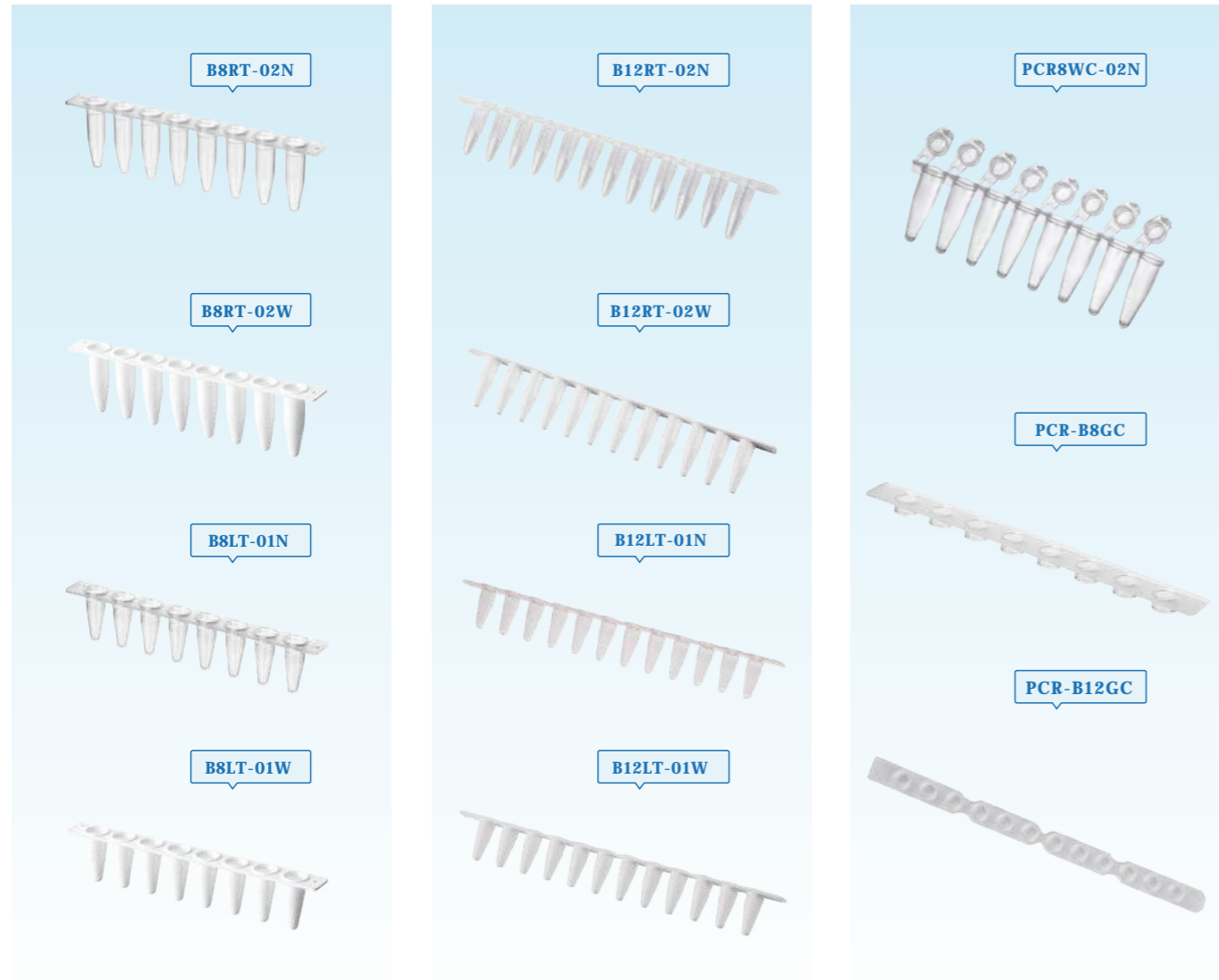

ORDER INFORMATION

Type	Color	Tube Numbers	Packaging	Cat.#	Quantity per Case	Size / Case (CM)			Weight / Case(Kg)
						L	W	H	
0.2mL, Regular profile	Nature	8 tubes	125 PCS/Box	PCR8WC-02N	10 Boxes (125 PCS/Box, 10 Boxes/Case)	50	41.5	16.5	2.00
0.2mL, Regular profile	Nature	8 tubes	125 PCS/Box	B8RT-02N	10 Boxes (125 PCS/Box, 10 Boxes/Case)	50	41.5	16.5	1.80
0.2mL, Regular profile	White	8 tubes	125 PCS/Box	B8RT-02W	10 Boxes (125 PCS/Box, 10 Boxes/Case)	50	41.5	16.5	1.80
0.1mL / 0.2mL, Low profile	Nature	8 tubes	125 PCS/Box	B8LT-01N	10 Boxes (125 PCS/Box, 10 Boxes/Case)	50	41.5	16.5	1.70
0.1mL / 0.2mL, Low profile	White	8 tubes	125 PCS/Box	B8LT-01W	10 Boxes (125 PCS/Box, 10 Boxes/Case)	50	41.5	16.5	1.70
0.2mL, Regular profile	Nature	12 tubes	125 PCS/Box	B12RT-02N	10 Boxes (125 PCS/Box, 10 Boxes/Case)	50	41.5	16.5	2.60
0.2mL, Regular profile	White	12 tubes	125 PCS/Box	B12RT-02W	10 Boxes (125 PCS/Box, 10 Boxes/Case)	50	41.5	16.5	2.60
0.1mL / 0.2mL, Low profile	Nature	12 tubes	125 PCS/Box	B12LT-01N	10 Boxes (125 PCS/Box, 10 Boxes/Case)	50	41.5	16.5	2.50
0.1mL / 0.2mL, Low profile	White	12 tubes	125 PCS/Box	B12LT-01W	10 Boxes (125 PCS/Box, 10 Boxes/Case)	50	41.5	16.5	2.50

ORDER INFORMATION

Type	Class	Cap Numbers	Packaging	Cat.#	Quantity per Case	Size / Case (CM)			Weight / Case(Kg)
						L	W	H	
Optical	Thin Wall	8 caps	125 PCS/Box	PCR-B8GC	10 Boxes (125 PCS/Box, 10 Boxes/Case)	50	41.5	16.5	1.45
Optical	Thin Wall	12 caps	125 PCS/Box	PCR-B12GC	10 Boxes (125 PCS/Box, 10 Boxes/Case)	50	41.5	16.5	2.20

PCR tubes

Down to
0.25
mm

- There are 4 kinds of single PCR tube available for supplying currently.
- uniform thin wall down to 0.25mm for optimal heat transfer.
- Conical bottom make less different during transfer.
- All tubes are produced in class 100,000 clean room. RNase and DNase free, endotoxin free, No Human DNA.

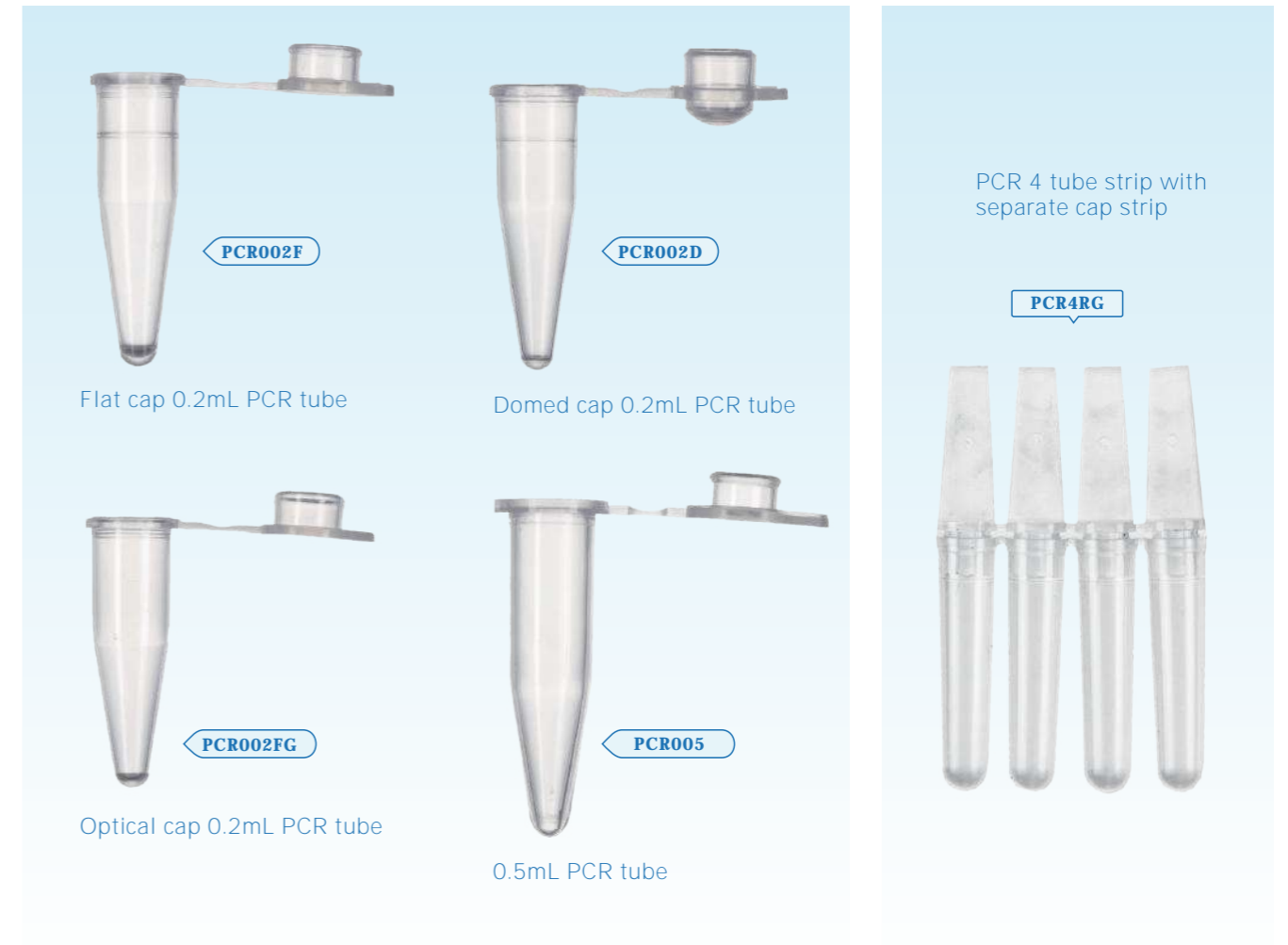

ORDER INFORMATION

Size	Cap type	Color	Packaging	Cat.#	Qty / Case	Size / Case (CM)			Weight / Case (kg)
						L	W	H	
0.2mL	Flat, frosting	Transparent	1000 PCS/Bag	PCR002F	10 Bags (1000PCS/Bag, 10 Bags/Case)	38	31	16	2.60
0.2mL	Optical	Transparent	1000 PCS/Bag	PCR002FG	10 Bags (1000PCS/Bag, 10 Bags/Case)	38	31	16	2.60
0.2mL	Domed	Transparent	1000 PCS/Bag	PCR002D	10 Bags (1000PCS/Bag, 10 Bags/Case)	38	31	16	2.60
0.5mL	Flat, frosting	Transparent	1000 PCS/Bag	PCR005	10 Bags (1000PCS/Bag, 10 Bags/Case)	48.5	29	30.5	4.95

PCR 4 tubes strip with separate cap strip

Size	Color	Tube Numbers	Packaging	Cat.#	Qty / Case	Size / Case (CM)			Weight / Case (kg)
						L	W	H	
0.1mL, Qiagen, Rotorgene	Nature	4 tubes	250 Kits/Box	PCR4RG	10 Boxes (250Kits/Box, 10 Boxes/Case)	49.5	30	22	2.40



Filter pipette tips

5 Racks per Pack Available!

Thinner wall of entrance brings you a softer hand feeling to reduce damage to the wrist in long-term use

More graduations could meet a wider variety of volume pipetting needs and achieve more precise pipetting.

Rack of the tips is up to ANSI-SLAS standard, which make it compatible with workstations using non-exclusive or non-specific tips.

E-short-10µL



E-long-10µL

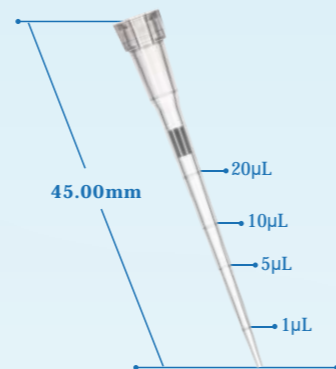

E-50µL



E-100µL

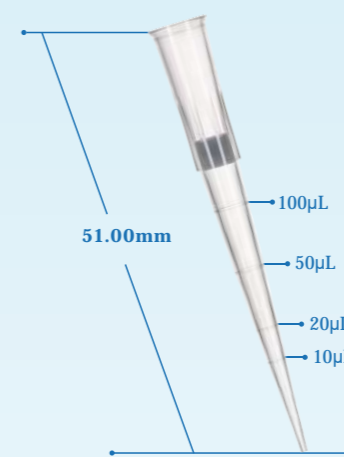

E-200µL

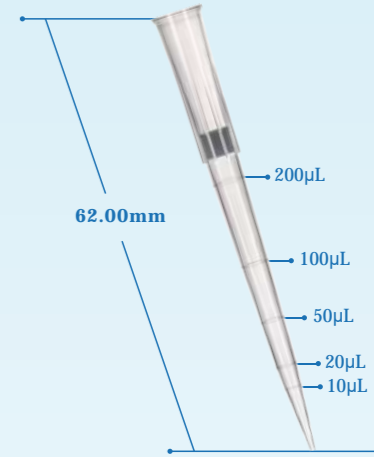

E-20µL

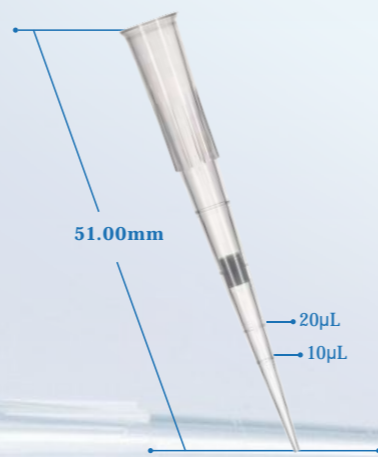

E-300µL



E-1000µL

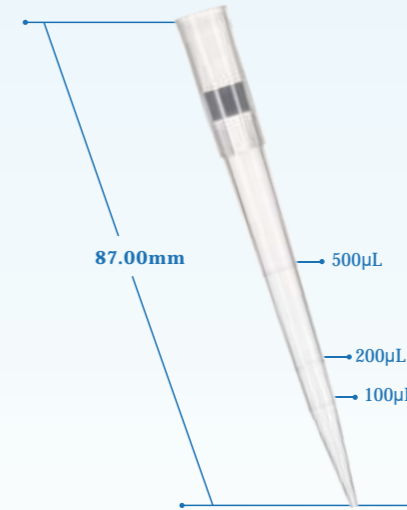

E-1250µL

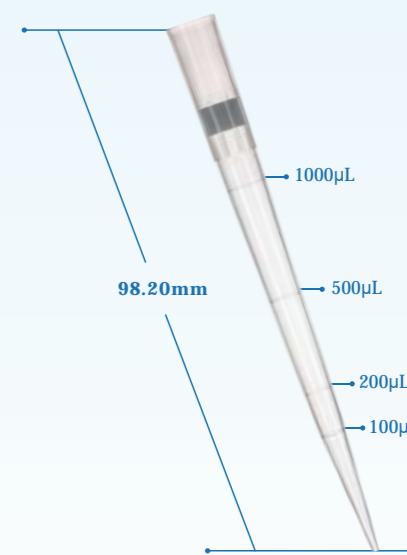

Filter pipette tips



Search "GenFollower" on Youtube or go to
["https://youtube.com/channel/UCLbB_rIWHnNHqceVrOtPgQQ"](https://youtube.com/channel/UCLbB_rIWHnNHqceVrOtPgQQ)



ORDER INFORMATION

Size	Packaging	Color	Class	Cat.#	Qty / Case	Size / Case (CM)			Weight / Case(Kg)
						L	W	H	
10µL, Short	96 tips/Rack	Nature	Common	E-FTR10S-S	50 Racks	37.5	31.7	54	7.18
10µL, Short	1000 tips/Bag	Nature		E-FTB10S	10 Bags	27	25	20	2.05
10µL, Short	96 tips/Rack	Nature	Ultra Low retention	E-FTR10S-L-S	50 Racks	37.5	31.7	54	7.18
10µL, Short	1000 tips/Bag	Nature		E-FTB10S-L	10 Bags	27	25	20	2.05
10µL, Long	96 tips/Rack	Nature	Common	E-FTR10GL-S	50 Racks	37.5	31.7	54	7.23
10µL, Long	1000 tips/Bag	Nature		E-FTB10GL	10 Bags	33	25	30	2.15
10µL, Long	96 tips/Rack	Nature	Ultra Low retention	E-FTR10GL-L-S	50 Racks	37.5	31.7	54	7.23
10µL, Long	1000 tips/Bag	Nature		E-FTB10GL-L	10 Bags	33	25	30	2.15
20µL	96 tips/Rack	Nature	Common	E-FTR20-S	50 Racks	45	31.7	54	8.72
20µL	1000 tips/Bag	Nature		E-FTB20	10 Bags	38.5	30	32.5	3.80
20µL	96 tips/Rack	Nature	Ultra Low retention	E-FTR20-L-S	50 Racks	45	31.7	54	8.72
20µL	1000 tips/Bag	Nature		E-FTB20-L	10 Bags	38.5	30	32.5	3.80
50µL	96 tips/Rack	Nature	Common	E-FTR50-S	50 Racks	45	31.7	54	8.72
50µL	1000 tips/Bag	Nature		E-FTB50	10 Bags	38.5	30	32.5	3.85
50µL	96 tips/Rack	Nature	Ultra Low retention	E-FTR50-L-S	50 Racks	45	31.7	54	8.72
50µL	1000 tips/Bag	Nature		E-FTB50-L	10 Bags	38.5	30	32.5	3.85
100µL	96 tips/Rack	Nature	Common	E-FTR100-S	50 Racks	45	31.7	54	8.82
100µL	1000 tips/Bag	Nature		E-FTB100	10 Bags	38.5	30	32.5	4.00
100µL	96 tips/Rack	Nature	Ultra Low retention	E-FTR100-L-S	50 Racks	45	31.7	54	8.82
100µL	1000 tips/Bag	Nature		E-FTB100-L	10 Bags	38.5	30	32.5	4.00
200µL	96 tips/Rack	Nature	Common	E-FTR200-S	50 Racks	45	31.7	54	9.12
200µL	1000 tips/Bag	Nature		E-FTB200	10 Bags	42.5	28	47.5	4.95
200µL	96 tips/Rack	Nature	Ultra Low retention	E-FTR200-L-S	50 Racks	45	31.7	54	9.12
200µL	1000 tips/Bag	Nature		E-FTB200-L	10 Bags	42.5	28	47.5	4.95
300µL	96 tips/Rack	Nature	Common	E-FTR300-S	50 Racks	45	31.7	54	9.17
300µL	1000 tips/Bag	Nature		E-FTB300	10 Bags	42.5	28	47.5	5.05
300µL	96 tips/Rack	Nature	Ultra Low retention	E-FTR300-L-S	50 Racks	45	31.7	54	9.17
300µL	1000 tips/Bag	Nature		E-FTB300-L	10 Bags	42.5	28	47.5	5.05
1000µL	96 tips/Rack	Nature	Common	E-FTR1000-S	50 Racks	70	37	50	13.30
1000µL	1000 tips/Bag	Nature		E-FTB1000	10 Bags	48	43	55	12.25
1000µL	96 tips/Rack	Nature	Ultra Low retention	E-FTR1000-L-S	50 Racks	70	37	50	13.30
1000µL	1000 tips/Bag	Nature		E-FTB1000-L	10 Bags	48	43	55	12.25
1250µL	96 tips/Rack	Nature	Common	E-FTR1250-S	50 Racks	70	37	50	13.50
1250µL	1000 tips/Bag	Nature		E-FTB1250	10 Bags	48	43	55	13.00
1250µL	96 tips/Rack	Nature	Ultra Low retention	E-FTR1250-L-S	50 Racks	70	37	50	13.50
1250µL	1000 tips/Bag	Nature		E-FTB1250-L	10 Bags	48	43	55	13.00

Filter pipette tips

Wide & Small bore Available!

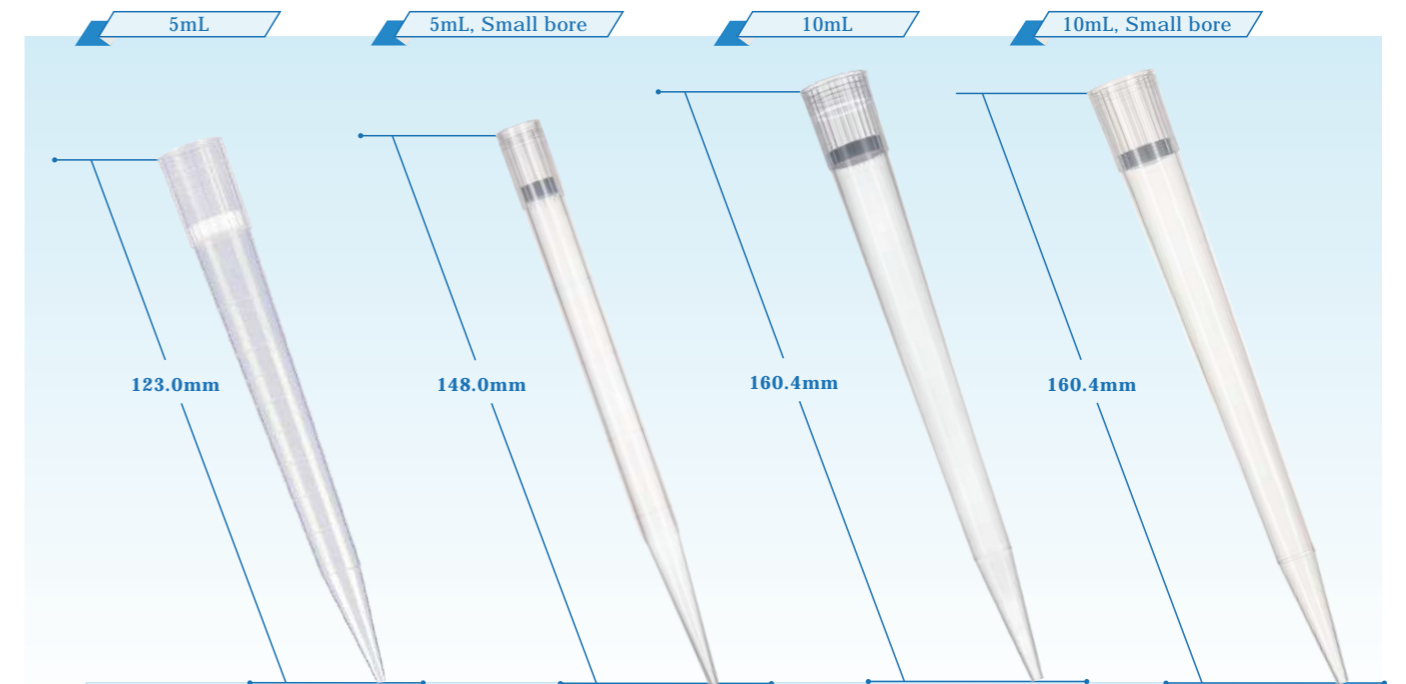

ORDER INFORMATION

Size	Packaging	Color	Class	Cat.#	Qty / Case	Size / Case (CM)			Weight / Case(Kg)
						L	W	H	
5000µL / 5mL	24 tips/Rack	Nature	Common	FTR5000-24	30 Racks	54	32	51	8.30
5000µL / 5mL	100 tips/Bag	Nature		FTB5000-10	10 Bags	50	30	40	3.30
5000µL / 5mL	24 tips/Rack	Nature	Ultra Low retention	FTR5000-24-R	30 Racks	54	32	51	8.30
5000µL / 5mL	100 tips/Bag	Nature		FTB5000-10-R	10 Bags	50	30	40	3.30
5000µL / 5mL, Small bore	40 tips/Rack	Nature	Common	FTR5000-40S	30 Racks	54	32	51	8.30
5000µL / 5mL, Small bore	100 tips/Bag	Nature		FTB5000-10S	10 Bags	50	30	40	3.30
10000µL / 10mL	24 tips/Rack	Nature	Common	FTR10000-24	30 Racks	54	32	51	8.30
10000µL / 10mL	100 tips/Bag	Nature		FTB10000-10	10 Bags	50	30	40	3.30
10000µL / 10mL	24 tips/Rack	Nature	Ultra Low retention	FTR10000-24-R	30 Racks	54	32	51	8.30
10000µL / 10mL	100 tips/Bag	Nature		FTB10000-10-R	10 Bags	50	30	40	3.30
10000µL / 10mL, Small bore	24 tips/Rack	Nature	Common	FTR10000-24S	30 Racks	54	32	51	8.30
10000µL / 10mL, Small bore	100 tips/Bag	Nature		FTB10000-10S	10 Bags	50	30	40	3.30
10000µL / 10mL, Small bore	24 tips/Rack	Nature	Ultra Low retention	FTR10000-24S-R	30 Racks	54	32	51	8.30
10000µL / 10mL, Small bore	100 tips/Bag	Nature		FTB10000-10S-R	10 Bags	50	30	40	3.30

Pipette tips



Search "GenFollower" on Youtube or go to
["https://youtube.com/channel/UCLbB_rIWHnNHqceVrOtPgQQ"](https://youtube.com/channel/UCLbB_rIWHnNHqceVrOtPgQQ)



5 Racks per Pack Available!

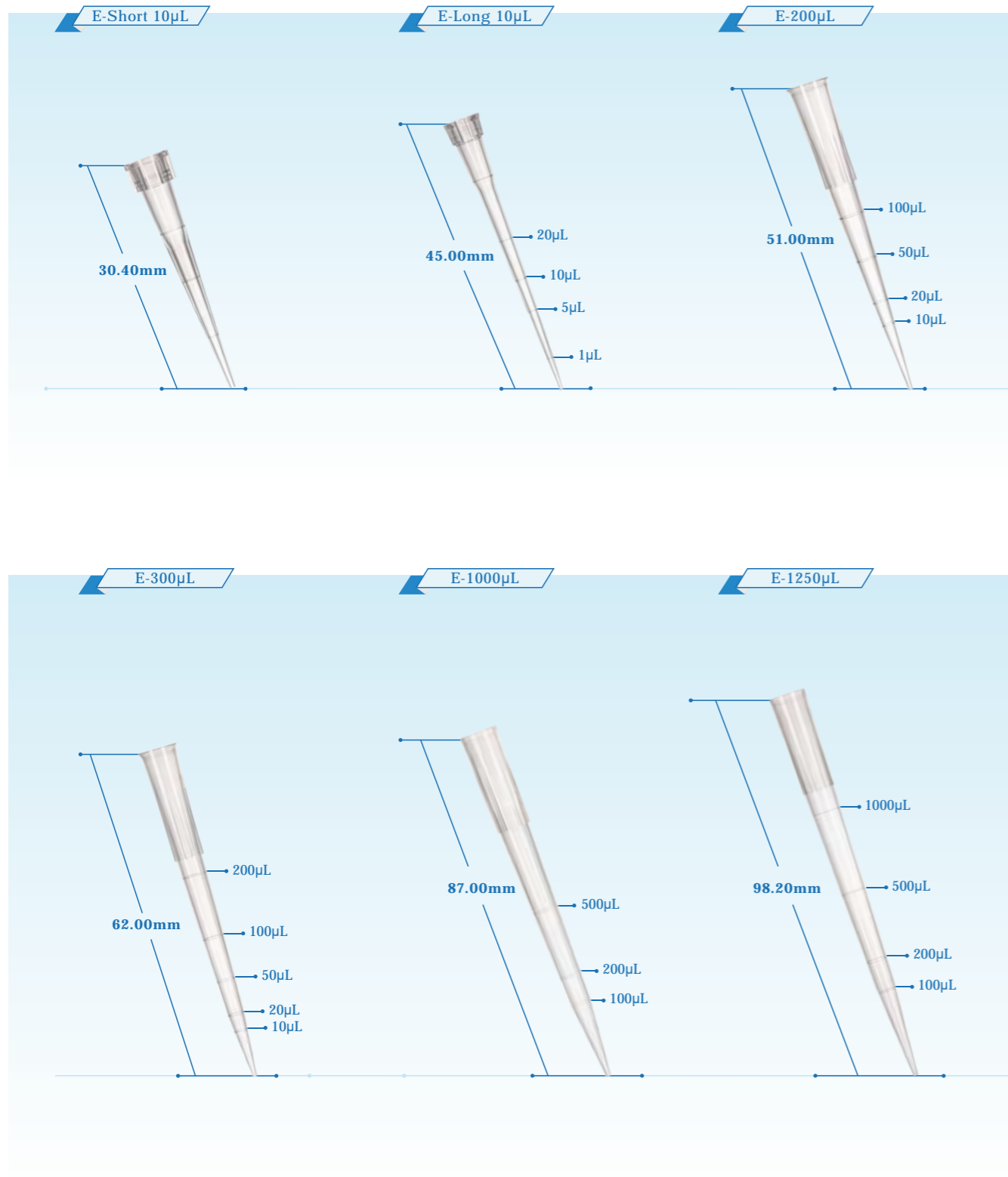

ORDER INFORMATION

Size	Packaging	Color	Class	Cat.#	Qty / Case	Size / Case (CM)			Weight / Case (kg)
						L	W	H	
10µL, Short	96 tips/Rack	Nature	Common	E-TR10S-S	50 Racks	37.5	31.7	54	7.13
10µL, Short	1000 tips/Bag	Nature		E-TB10S	10 Bags	27	25	20	1.65
10µL, Short	96 tips/Rack	Nature	Ultra Low retention	E-TR10S-L-S	50 Racks	37.5	31.7	54	7.13
10µL, Short	1000 tips/Bag	Nature		E-TB10S-L	10 Bags	27	25	20	1.65
10µL, Long	96 tips/Rack	Nature	Common	E-TR10GL-S	50 Racks	37.5	31.7	54	7.13
10µL, Long	1000 tips/Bag	Nature		E-TB10GL	10 Bags	33	25	30	1.95
10µL, Long	96 tips/Rack	Nature	Ultra Low retention	E-TR10GL-L-S	50 Racks	37.5	31.7	54	7.13
10µL, Long	1000 tips/Bag	Nature		E-TB10GL-L	10 Bags	33	25	30	1.95
200µL	96 tips/Rack	Nature	Common	E-TR200-S	50 Racks	45	31.7	54	8.52
200µL	1000 tips/Bag	Nature		E-TB200	10 Bags	38.5	30	32.5	3.40
200µL	96 tips/Rack	Nature	Ultra Low retention	E-TR200-L-S	50 Racks	45	31.7	54	8.52
200µL	1000 tips/Bag	Nature		E-TB200-L	10 Bags	38.5	30	32.5	3.40
300µL	96 tips/Rack	Nature	Common	E-TR300-S	50 Racks	45	31.7	54	9.02
300µL	1000 tips/Bag	Nature		E-TB300	10 Bags	42.5	28	47.5	4.30
300µL	96 tips/Rack	Nature	Ultra Low retention	E-TR300-L-S	50 Racks	45	31.7	54	9.02
300µL	1000 tips/Bag	Nature		E-TB300-L	10 Bags	42.5	28	47.5	4.30
1000µL	96 tips/Rack	Nature	Common	E-TR1000-S	50 Racks	70	37	50	12.60
1000µL	1000 tips/Bag	Nature		E-TB1000	10 Bags	48	43	55	10.60
1000µL	96 tips/Rack	Nature	Ultra Low retention	E-TR1000-L-S	50 Racks	70	37	50	12.60
1000µL	1000 tips/Bag	Nature		E-TB1000-L	10 Bags	48	43	55	10.60
1250µL	96 tips/Rack	Nature	Common	E-TR1250-S	50 Racks	70	37	50	12.80
1250µL	1000 tips/Bag	Nature		E-TB1250	10 Bags	48	43	55	11.00
1250µL	96 tips/Rack	Nature	Ultra Low retention	E-TR1250-L-S	50 Racks	70	37	50	12.80
1250µL	1000 tips/Bag	Nature		E-TB1250-L	10 Bags	48	43	55	11.00





Search "GenFollower" on Youtube or go to
["https://youtube.com/channel/UCLbB_rIWHnNHqceVrOtPgQQ"](https://youtube.com/channel/UCLbB_rIWHnNHqceVrOtPgQQ)

Pipette tips

Wide & Small bore Available!

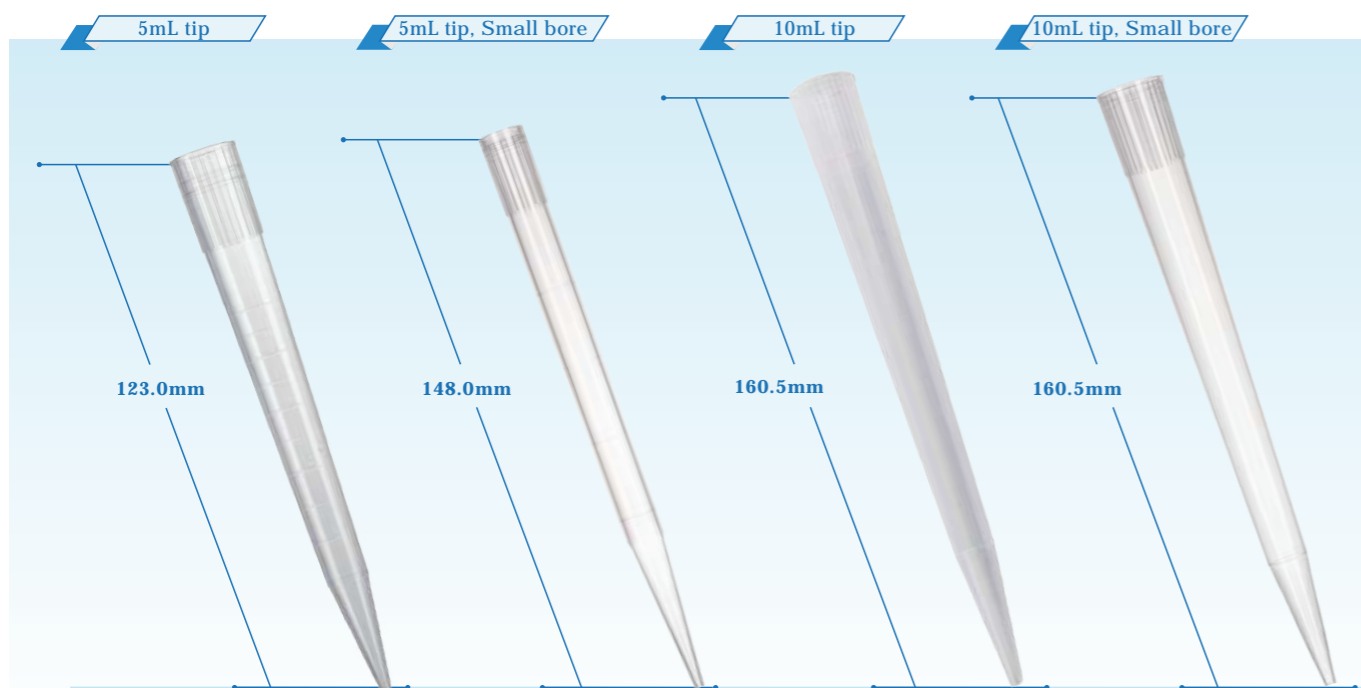

ORDER INFORMATION

Size	Packaging	Color	Class	Cat.#	Qty / Case	Size / Case (CM)			Weight / Case(kg)
						L	W	H	
5000µL / 5mL	24 tips/Rack	Nature	Common	TR5000-24	30 Racks	54	32	55	8.30
5000µL / 5mL	100 tips/Bag	Nature		TB5000-10	10 Bags	46	37	23	3.10
5000µL / 5mL	24 tips/Rack	Nature	Ultra Low retention	TR5000-24-R	30 Racks	54	32	55	8.30
5000µL / 5mL	100 tips/Bag	Nature		TB5000-10-R	10 Bags	46	37	23	3.10
5000µL / 5mL, Small bore	40 tips/Rack	Nature	Common	TR5000-40S	30 Racks	54	32	55	8.30
5000µL / 5mL, Small bore	100 tips/Bag	Nature		TB5000-10S	10 Bags	46	37	23	3.10
10000µL / 10mL	24 tips/Rack	Nature	Common	TR10000-24	30 Racks	54	32	55	8.30
10000µL / 10mL	100 tips/Bag	Nature		TB10000-10	10 Bags	46	37	23	3.10
10000µL / 10mL	24 tips/Rack	Nature	Ultra Low retention	TR10000-24-R	30 Racks	54	32	55	8.30
10000µL / 10mL	100 tips/Bag	Nature		TB10000-10-R	10 Bags	46	37	23	3.10
10000µL / 10mL, Small bore	24 tips/Rack	Nature	Common	TR10000-24S	30 Racks	54	32	55	8.30
10000µL / 10mL, Small bore	100 tips/Bag	Nature		TB10000-10S	10 Bags	46	37	23	3.10
10000µL / 10mL, Small bore	24 tips/Rack	Nature	Ultra Low retention	TR10000-24S-R	30 Racks	54	32	55	8.30
10000µL / 10mL, Small bore	100 tips/Bag	Nature		TB10000-10S-R	10 Bags	46	37	23	3.10

Reagent Reservoirs

• Special design for stream guidance at the 4 corners, save precious reagents when pour back to bottles.

• V bottom easier for pipetting.



ORDER INFORMATION

Max Graduation	Max Volume	Material	Packaging	Cat.#	Quantity per Case	Size / Case (CM)			Weight / Case(kg)
						L	W	H	
25mL	60mL	PVC	10PCS/Bag	RC00025	100 PCS/Case	38	31	16	2.10

Filter tips for RAININ LTS

Ultra Low Retention Available!

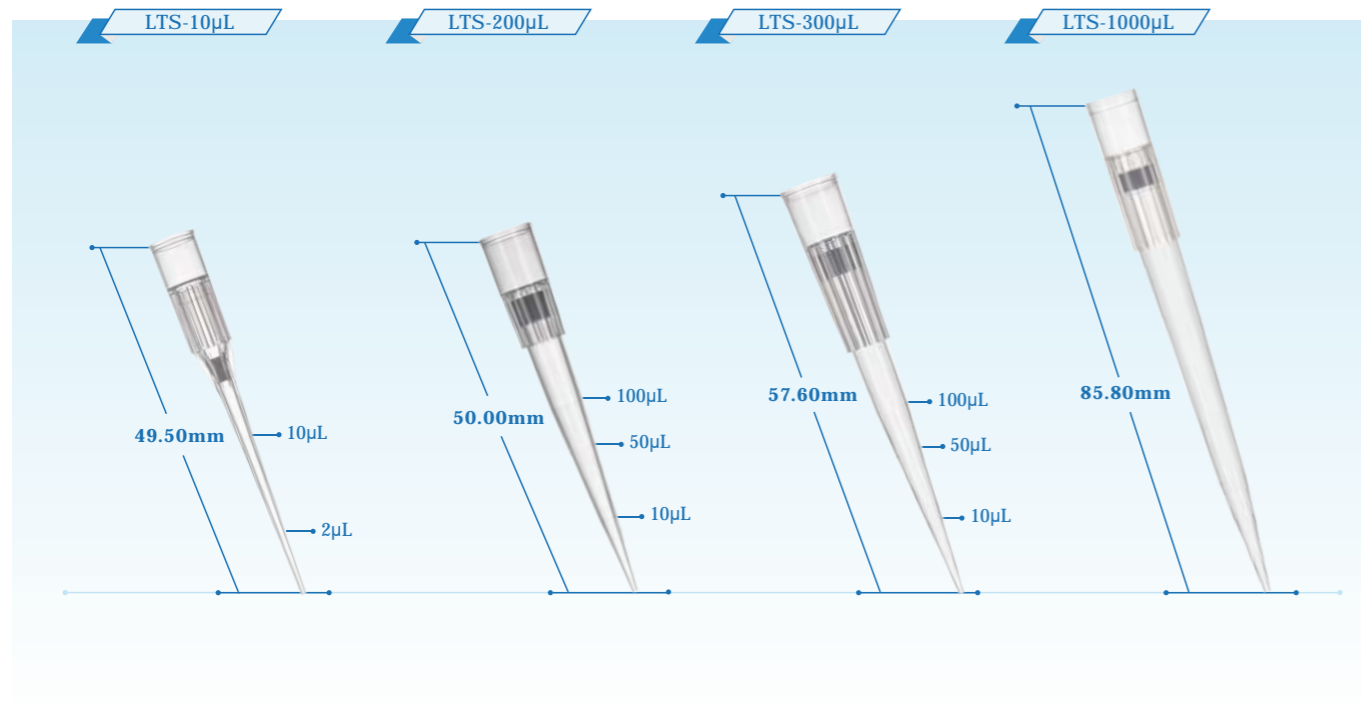

ORDER INFORMATION

Size	Packaging	Color	Class	Cat.#	Qty / Case	Size / Case (CM)			Weight / Case(kg)
						L	W	H	
10µL, CC Rack: for Manual Use	96 tips/Rack	Nature	Common	LTS-FTR10-S	50 Racks	48	28	40	7.45
10µL	1000 tips/Bag	Nature		LTS-FTB10	10 Bags	44	26	21	2.10
10µL, CC Rack: for Manual Use	96 tips/Rack	Nature	Ultra Low retention	LTS-FTR10-L-S	50 Racks	48	28	40	7.45
10µL	1000 tips/Bag	Nature		LTS-FTB10-L	10 Bags	44	26	21	2.10
200µL, CC Rack: for Manual Use	96 tips/Rack	Nature	Common	LTS-FTR200-S	50 Racks	48	28	40	7.90
200µL	1000 tips/Bag	Nature		LTS-FTB200	10 Bags	46.5	26.5	27	4.00
200µL, CC Rack: for Manual Use	96 tips/Rack	Nature	Ultra Low retention	LTS-FTR200-L-S	50 Racks	48	28	40	7.90
200µL	1000 tips/Bag	Nature		LTS-FTB200-L	10 Bags	46.5	26.5	27	4.00
300µL, CC Rack: for Manual Use	96 tips/Rack	Nature	Common	LTS-FTR300-S	50 Racks	48	28	40	8.35
300µL	1000 tips/Bag	Nature		LTS-FTB300	10 Bags	46.5	26.5	27	4.15
300µL, CC Rack: for Manual Use	96 tips/Rack	Nature	Ultra Low retention	LTS-FTR300-L-S	50 Racks	48	28	40	8.35
300µL	1000 tips/Bag	Nature		LTS-FTB300-L	10 Bags	46.5	26.5	27	4.15
1000µL, CC Rack: for Manual Use	96 tips/Rack	Nature	Common	LTS-FTR1000-S	50 Racks	48	28	60.5	12.45
1000µL	1000 tips/Bag	Nature		LTS-FTB1000	10 Bags	69	31	48	11.85
1000µL, CC Rack: for Manual Use	96 tips/Rack	Nature	Ultra Low retention	LTS-FTR1000-L-S	50 Racks	48	28	60.5	12.45
1000µL	1000 tips/Bag	Nature		LTS-FTB1000-L	10 Bags	69	31	48	11.85



Search "GenFollower" on Youtube or go to
["https://youtube.com/channel/UCLbB_r1WHnNHqceVrOtPgQQ"](https://youtube.com/channel/UCLbB_r1WHnNHqceVrOtPgQQ)



Pipette tips for RAININ LTS

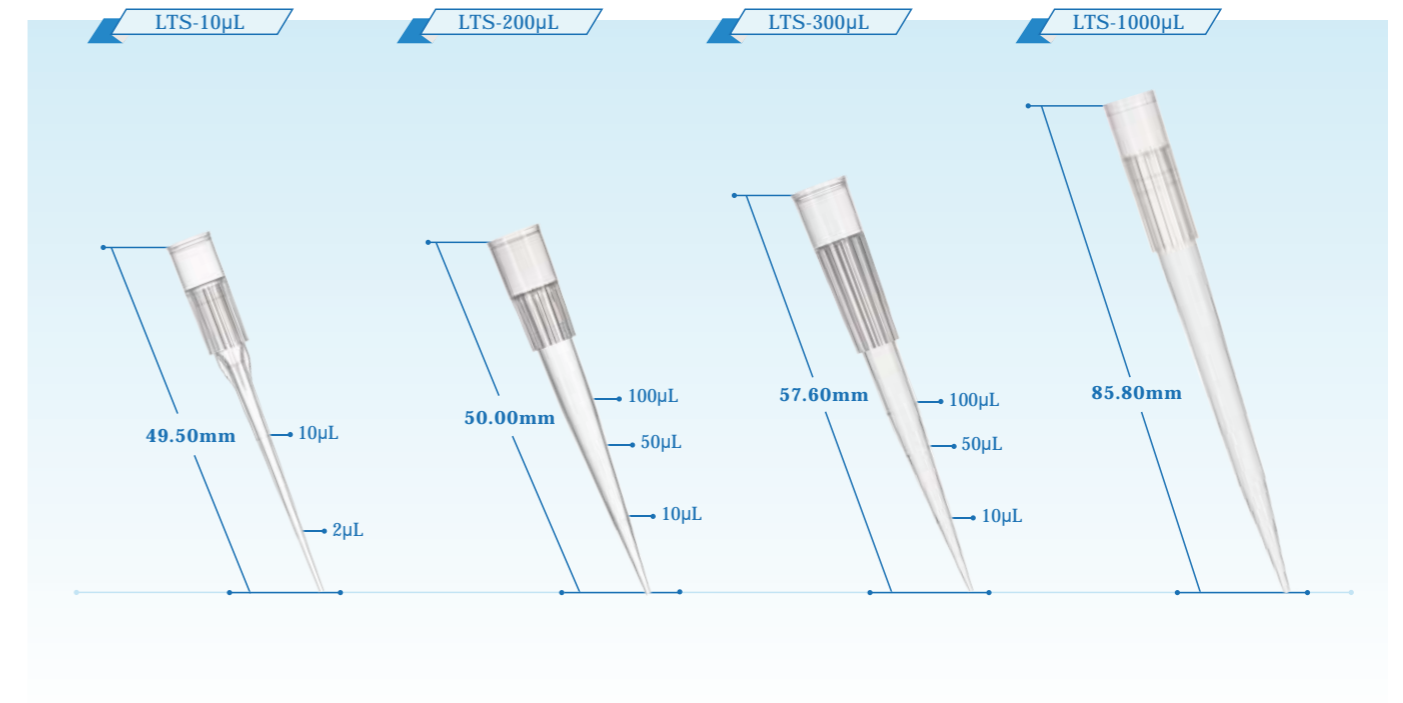

ORDER INFORMATION

Size	Packaging	Color	Class	Cat.#	Qty / Case	Size / Case (CM)			Weight / Case(kg)
						L	W	H	
10µL, CC Rack: for Manual Use	96 tips/Rack	Nature	Common	LTS-TR10-S	50 Racks	48	28	40	7.45
10µL	1000 tips/Bag	Nature		LTS-TB10	10 Bags	44	26	21	2.25
10µL, CC Rack: for Manual Use	96 tips/Rack	Nature	Ultra Low retention	LTS-TR10-L-S	50 Racks	48	28	40	7.45
10µL	1000 tips/Bag	Nature		LTS-TB10-L	10 Bags	44	26	21	2.25
200µL, CC Rack: for Manual Use	96 tips/Rack	Nature	Common	LTS-TR200-S	50 Racks	48	28	40	7.80
200µL	1000 tips/Bag	Nature		LTS-TB200	10 Bags	46.5	26.5	27	3.50
200µL, CC Rack: for Manual Use	96 tips/Rack	Nature	Ultra Low retention	LTS-TR200-L-S	50 Racks	48	28	40	7.80
200µL	1000 tips/Bag	Nature		LTS-TB200-L	10 Bags	46.5	26.5	27	3.50
300µL, CC Rack: for Manual Use	96 tips/Rack	Nature	Common	LTS-TR300-S	50 Racks	48	28	40	8.20
300µL	1000 tips/Bag	Nature		LTS-TB300	10 Bags	46.5	26.5	27	4.20
300µL, CC Rack: for Manual Use	96 tips/Rack	Nature	Ultra Low retention	LTS-TR300-L-S	50 Racks	48	28	40	8.20
300µL	1000 tips/Bag	Nature		LTS-TB300-L	10 Bags	46.5	26.5	27	4.20
1000µL, CC Rack: for Manual Use	96 tips/Rack	Nature	Common	LTS-TR1000-S	50 Racks	48	28	60.5	12.15
1000µL	1000 tips/Bag	Nature		LTS-TB1000	10 Bags	69	31	48	10.65
1000µL, CC Rack: for Manual Use	96 tips/Rack	Nature	Ultra Low retention	LTS-TR1000-L-S	50 Racks	48	28	60.5	12.15
1000µL	1000 tips/Bag	Nature		LTS-TB1000-L	10 Bags	69	31	48	10.65

Robotic tips



For HA Liquid Handling Systems

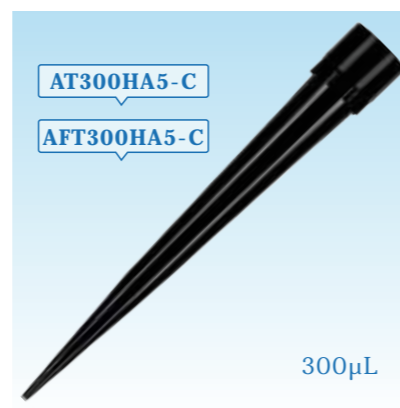

ORDER INFORMATION

Size	Compatiblity	Packaging	Cat.#	Qty / Case	Size / Case (CM)			Weight/ Case(kg)
					L	W	H	
50µL, Clear, with Filter	HA Liquid Handling Systems	96 x 5/Unit	AFT50HA5	12Units	49	34	44	5.95
50µL, Clear, Non-Filter	HA Liquid Handling Systems	96 x 5/Unit	AT50HA5	12Units	49	34	44	6.35
50µL, Conductive, with Filter	HA Liquid Handling Systems	96 x 5/Unit	AFT50HA5-C	12Units	49	34	44	5.85
50µL, Conductive, Non-Filter	HA Liquid Handling Systems	96 x 5/Unit	AT50HA5-C	12Units	49	34	44	6.25
300µL, Clear, with Filter	HA Liquid Handling Systems	96 x 5/Unit	AFT300HA5	12Units	49	34	44	6.85
300µL, Clear, Non-Filter	HA Liquid Handling Systems	96 x 5/Unit	AT300HA5	12Units	49	34	44	7.25
300µL, Conductive, with Filter	HA Liquid Handling Systems	96 x 5/Unit	AFT300HA5-C	12Units	49	34	44	6.75
300µL, Conductive, Non-Filter	HA Liquid Handling Systems	96 x 5/Unit	AT300HA5-C	12Units	49	34	44	7.15
1000µL, Clear, with Filter	HA Liquid Handling Systems	96 x 5/Unit	AFT1000HA5	8Units	49	34	44	7.10
1000µL, Clear, Non-Filter	HA Liquid Handling Systems	96 x 5/Unit	AT1000HA5	8Units	49	34	44	7.50
1000µL, Conductive, with Filter	HA Liquid Handling Systems	96 x 5/Unit	AFT1000HA5-C	8Units	49	34	44	7.00
1000µL, Conductive, Non-Filter	HA Liquid Handling Systems	96 x 5/Unit	AT1000HA5-C	8Units	49	34	44	7.40



ORDER INFORMATION

Size	Compatiblity	Packaging	Cat.#	Qty / Case	Size / Case (CM)			Weight/ Case(kg)
					L	W	H	
300µL, Non-Filter, Conductive, Wide bore	HA Liquid Handling Systems	96 x 5/Unit	AT300WH5-C	12Units	49	35	45	7.20

Robotic tips

For TECAN Liquid Handling Systems

Robotic tips for liquid handling and flexible channel arms designed for TECAN liquid handling systems. Filter & Non-filter, Conductive & Clear tips are all available

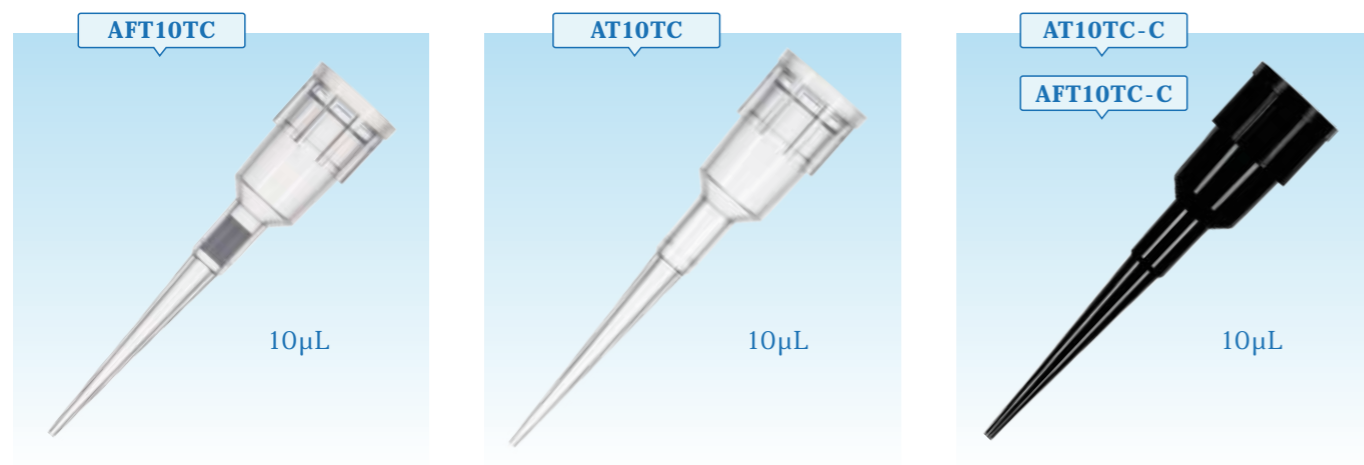

Robotic tips

Robotic tips for TECAN

Size	Compatibility	Packaging	Cat.#	Qty / Case	Size / Case (CM)			Weight / Case(Kg)
					L	W	H	
10µL, Clear, with Filter	Freedom	96 tips/Rack	AFT10TC	24 Racks	40.5	28.5	23.5	3.35
10µL, Clear, Non-Filter	Freedom	96 tips/Rack	AT10TC	24 Racks	40.5	28.5	23.5	3.25
10µL, Conductive, with Filter	Freedom	96 tips/Rack	AFT10TC-C	24 Racks	40.5	28.5	23.5	3.40
10µL, Conductive, Non-Filter	Freedom	96 tips/Rack	AT10TC-C	24 Racks	40.5	28.5	23.5	3.30
50µL, Clear, with Filter	Freedom	96 tips/Rack	AFT50TC	24 Racks	55.5	30	23	4.10
50µL, Clear, Non-Filter	Freedom	96 tips/Rack	AT50TC	24 Racks	55.5	30	23	4.00
50µL, Conductive, with Filter	Freedom	96 tips/Rack	AFT50TC-C	24 Racks	55.5	30	23	4.15
50µL, Conductive, Non-Filter	Freedom	96 tips/Rack	AT50TC-C	24 Racks	55.5	30	23	4.05
200µL, Clear, with Filter	Freedom	96 tips/Rack	AFT200TC	24 Racks	55.5	30	23	4.20
200µL, Clear, Non-Filter	Freedom	96 tips/Rack	AT200TC	24 Racks	55.5	30	23	4.10
200µL, Conductive, with Filter	Freedom	96 tips/Rack	AFT200TC-C	24 Racks	55.5	30	23	4.25
200µL, Conductive, Non-Filter	Freedom	96 tips/Rack	AT200TC-C	24 Racks	55.5	30	23	4.15
1000µL, Clear, with Filter	Freedom	96 tips/Rack	AFT1000TC	24 Racks	55.5	30	23	5.55
1000µL, Clear, Non-Filter	Freedom	96 tips/Rack	AT1000TC	24 Racks	55.5	30	23	5.40
1000µL, Conductive, with Filter	Freedom	96 tips/Rack	AFT1000TC-C	24 Racks	55.5	30	23	5.60
1000µL, Conductive, Non-Filter	Freedom	96 tips/Rack	AT1000TC-C	24 Racks	55.5	30	23	5.45

For Zymark Liquid Handling Systems

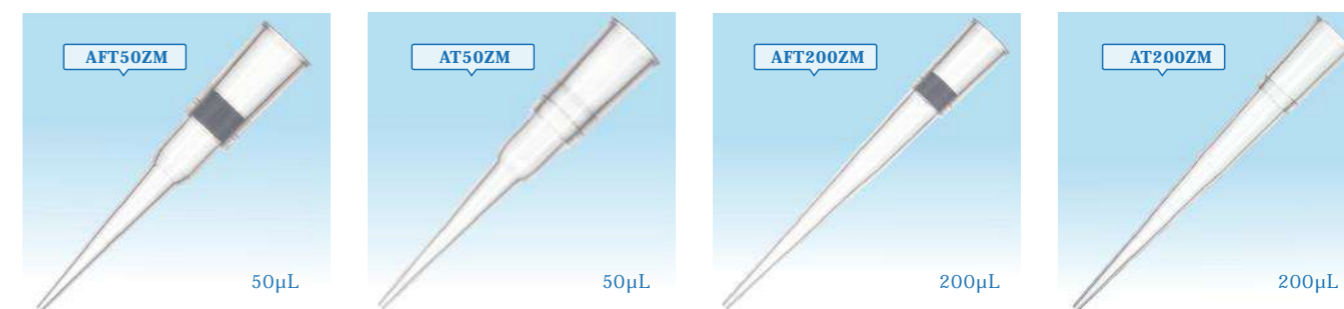

ORDER INFORMATION

Size	Compatibility	Packaging	Cat.#	Qty / Case	Size / Case (CM)			Weight / Case(Kg)
					L	W	H	
50µL, With Filter	for Zymark Liquid Handling Systems	96 tips/Rack	AFT50ZM	50Racks	48	34.5	28	9.95
50µL, Non-Filter	for Zymark Liquid Handling Systems	96 tips/Rack	AT50ZM	50 Racks	48	34.5	28	9.70
200µL, With Filter	for Zymark Liquid Handling Systems	96 tips/Rack	AFT200ZM	50 Racks	48	34.5	28	10.35
200µL, Non-Filter	for Zymark Liquid Handling Systems	96 tips/Rack	AT200ZM	50 Racks	48	34.5	28	10.25

For TECAN MCA Liquid Handling Systems

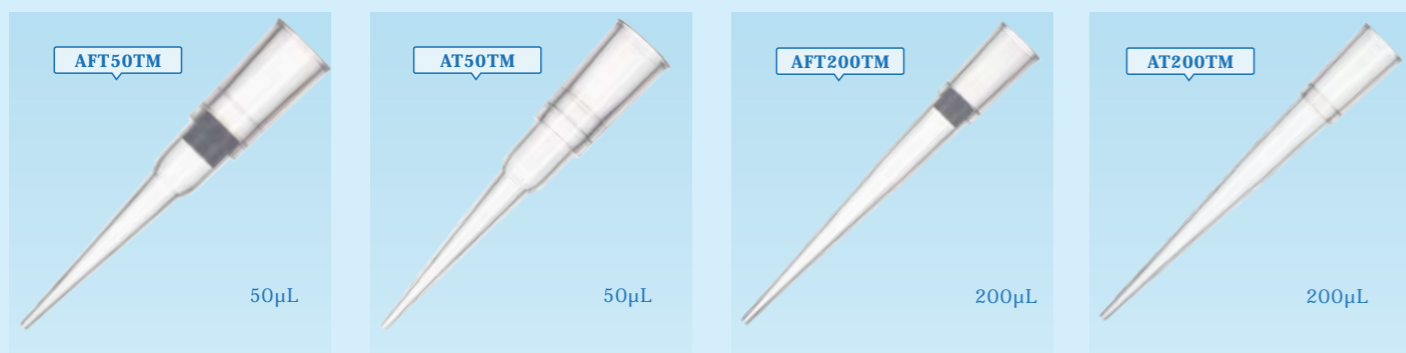

ORDER INFORMATION

Size	Compatibility	Packaging	Cat.#	Qty / Case	Size / Case (CM)			Weight / Case(Kg)
					L	W	H	
50µL, with Filter	for TECAN MCA Liquid Handling Systems	96 tips/Rack	AFT50TM	50 Racks	48	34.5	28	9.95
50µL, Non-Filter	for TECAN MCA Liquid Handling Systems	96 tips/Rack	AT50TM	50 Racks	48	34.5	28	9.70
200µL, with Filter	for TECAN MCA Liquid Handling Systems	96 tips/Rack	AFT200TM	50 Racks	48	34.5	28	10.35
200µL, Non-Filter	for TECAN MCA Liquid Handling Systems	96 tips/Rack	AT200TM	50 Racks	48	34.5	28	10.25

For Agilent Liquid Handling Systems



ORDER INFORMATION

Size	Compatibility	Packaging	Cat.#	Qty / Case	Size / Case (CM)			Weight / Case(Kg)
					L	W	H	
30µL, Non-Filter	for Agilent Liquid Handling Systems	384Tips/Rack	AT30AG	50 Racks	48	35	28	10.50
250µL, Non-Filter, Wide bore	for Agilent Liquid Handling Systems	96Tips/Rack	AT250WA	50 Racks	50	28.5	40.5	12.15

Robotic tips

For OPENTRONS Liquid Handling Systems



Robotic tips for OPENTRONS

Size	Compatibility	Packaging	Cat.#	Qty / Case	Size / Case (CM)			Weight / Case(Kg)
					L	W	H	
20µL, Filter	Opentrons Electronic Pipettes	96 tips/Rack	AFT20-OT	50 Racks	50	28.5	40.5	11.30
20µL, Non-Filter	Opentrons Electronic Pipettes	96 tips/Rack	AT20-OT	50 Racks	50	28.5	40.5	11.00
20µL, Non-Filter	Opentrons Electronic Pipettes	960 tips/Refill unit	AT20-OT-RS	10 Units	45.5	27	26.5	8.40
200µL, Filter	Opentrons Electronic Pipettes	96 tips/Rack	AFT200-OT	50 Racks	50	28.5	40.5	12.65
300µL, Non-Filter	Opentrons Electronic Pipettes	96 tips/Rack	AT300-OT	50 Racks	50	28.5	40.5	12.15
300µL, Non-Filter	Opentrons Electronic Pipettes	960 tips/Refill unit	AT300-OT-RS	10 Units	45.5	27	26.5	8.60
1000µL, Filter	Opentrons Electronic Pipettes	96 tips/Rack	AFT1000-OT	50 Racks	47.5	28.5	59.5	16.75
1000µL, Non-Filter	Opentrons Electronic Pipettes	96 tips/Rack	AT1000-OT	50 Racks	47.5	28.5	59.5	16.25
1000µL, Non-Filter	Opentrons Electronic Pipettes	480 tips/Refill unit	AT1000-OT-RS	10 Units	45.5	27	26.5	9.00

For BKM Liquid Handling Systems



Robotic tips for BKM

Size	Compatibility	Packaging	Cat.#	Qty / Case	Size / Case (CM)			Weight / Case(Kg)
					L	W	H	
20µL, Filter	BKM Coulter Biomek 3000	96 tips/Rack	AFT20BK	50 Racks	46	27	35.5	8.10
50µL, Filter	BKM Coulter Biomek 3000	96 tips/Rack	AFT50BK	50 Racks	46	27	35.5	8.30
250µL, Filter	BKM Coulter Biomek 3000	96 tips/Rack	AFT250BK	50 Racks	46	27	35.5	8.50



Deep well plates

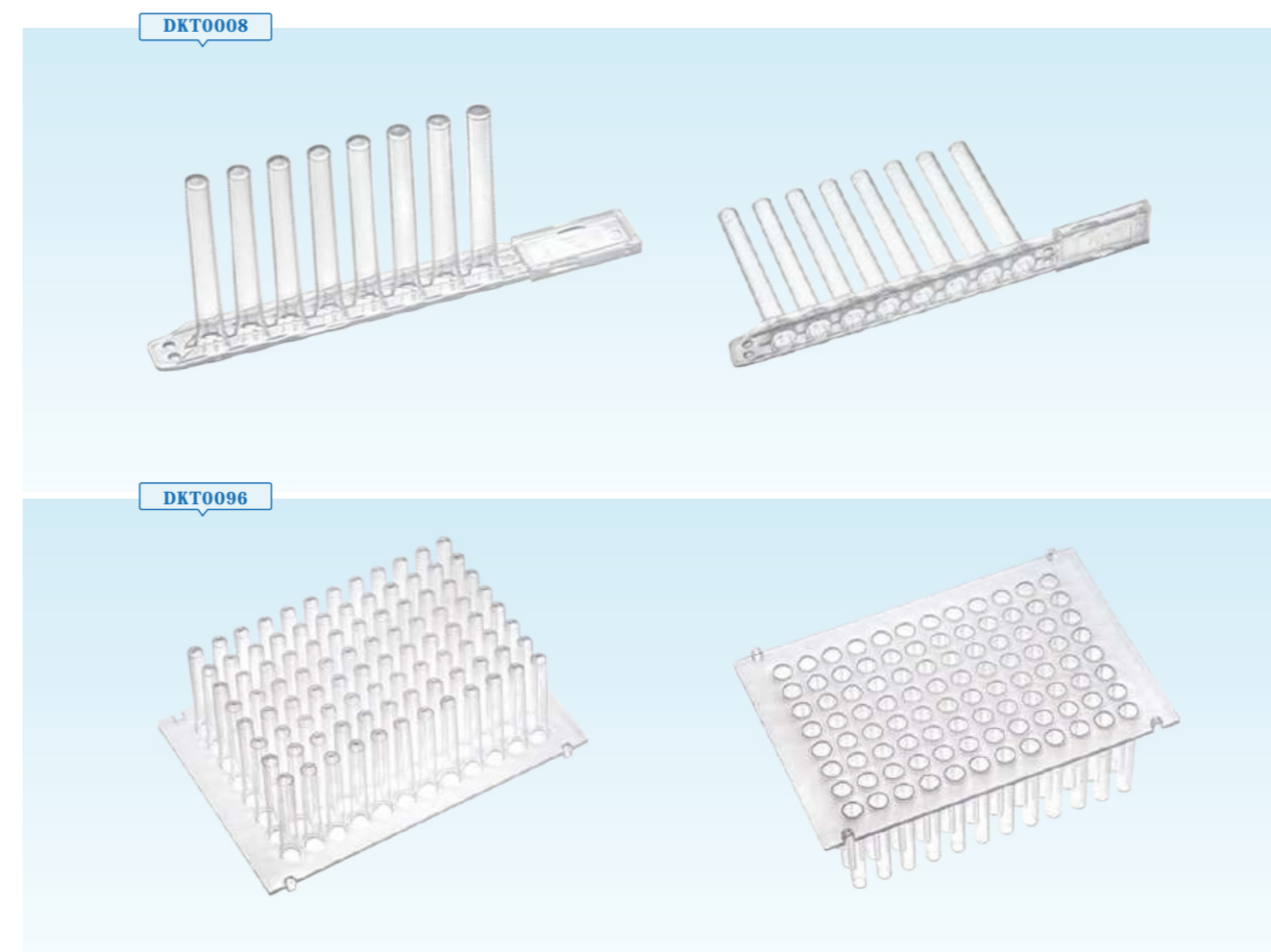
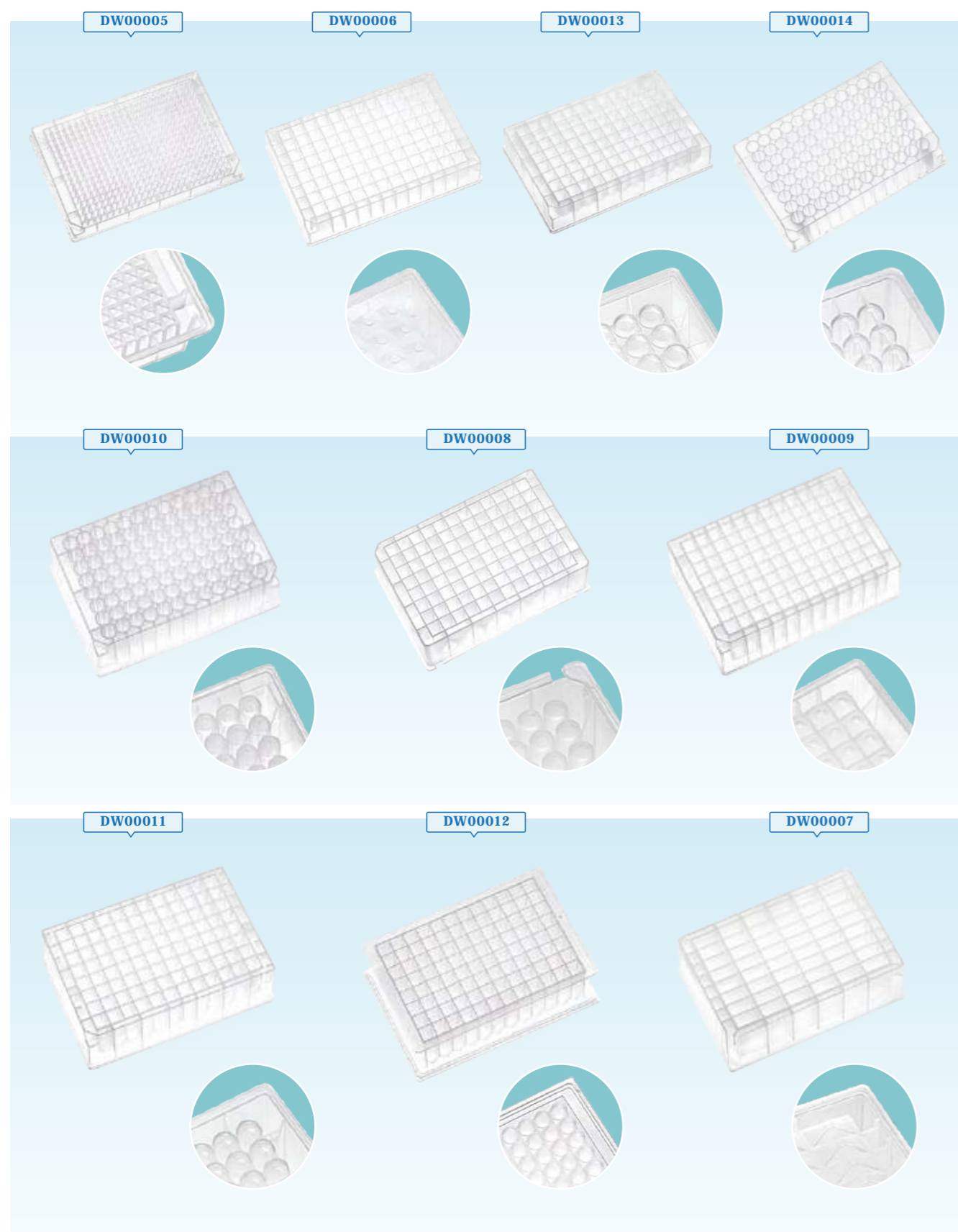

Deep well plates										
Size	Type	Number of wells	Packaging	Cat.#	Qty / Case	Size / Case (CM)			Weight / Case(kg)	
						L	W	H		
120µL	Square well, V bottom	384	10PCS/Bag	DW00005	100PCS	45	28	25	7.80	
1.2mL	Square well, V bottom	96	10PCS/Bag	DW00006	100PCS	45	28	25	6.50	
1.2mL	Square well, U bottom	96	10PCS/Bag	DW00013	50PCS	45	28	25	6.50	
1.2mL	Round well, U bottom	96	10PCS/Bag	DW00014	100PCS	45	28	25	6.50	
2.0mL	Round well, U bottom	96	5PCS/Bag	DW00010	50PCS	45	28	25	5.00	
2.2mL	Square well, Conical bottom	96	5PCS/Bag	DW00008	50PCS	45	28	25	5.00	
2.2mL	Square well, V bottom	96	5PCS/Bag	DW00009	50PCS	45	28	25	5.00	
2.2mL	Square well, U bottom	96	5PCS/Bag	DW00011	50PCS	45	28	25	5.00	
2.2mL	Square well, U bottom	96	5PCS/Bag	DW00012	50PCS	45	28	25	5.50	
5.0ml	Rectangle Well, V bottom	48	5PCS/Bag	DW00007	50PCS	45	28	25	6.20	

Tip comb							
Size	Packaging	Cat.#	Quantity per Case	Size / Case (CM)			Weight / Case(kg)
				L	W	H	
8 Tips Comb	1PCS/Bag	DKT0008	400 Bags (20Bags/Box, 20Boxes/Case)	37	29	28	2.80
96 Tips Comb	2PCS/Bag	DKT0096	50Bags (5Bags/Box, 10Boxes/Case)	45	28	25	3.50

Tip comb

ELISA plates

- C bottom & F bottom are both available .
- SBS footprint could work with many brands of automatic working station.
- detachable plate is convenient for researchers to transfer sample for different treatment.

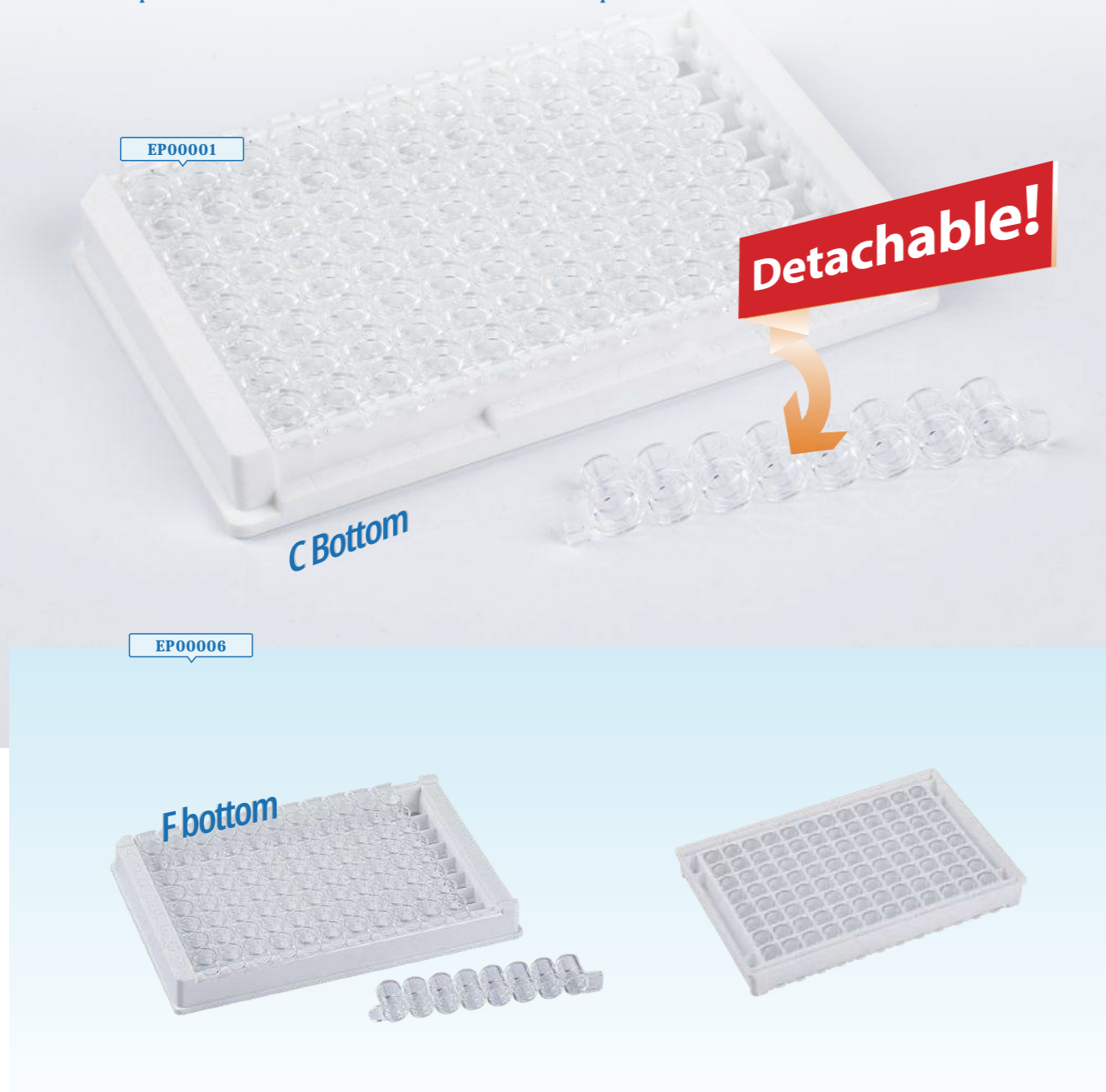

ORDER INFORMATION

Size	Type	Material	Packaging	Cat.#	Quantity per Case	Size / Case (CM)			Weight / Case(Kg)
						L	W	H	
0.2mL x 96, C bottom, High binding	Detachable	ABS+PS	10PCS/Bag	EP00001H	10 Bags/Case	50	31	16	6.00
0.2mL x 96, C bottom, Middle binding	Detachable	ABS+PS	10PCS/Bag	EP00001M	10 Bags/Case	50	31	16	6.00
0.2mL x 96, F bottom, High binding	Detachable	ABS+PS	10PCS/Bag	EP00006H	10 Bags/Case	50	31	16	6.00

Centrifuge tubes

Maximum to
12,000
xg

• We now are supplying 4 kinds of screw cap centrifuge tubes.

1. maximum centrifuge force up to 12,000xg
2. clear graduations and highly visible marking areas
3. Nonpyrogenic and DNase-/RNase-free



ORDER INFORMATION

Size	Packaging	Type	Color of cap	Cat.#	Quantity per Case	Size / Case (CM)			Weight / Case(Kg)
						L	W	H	
15mL	25 PCS/Bag	Conical	Yellow	CTB15YE	20 Bags (25 PCS/Bag, 20 Bags/Case)	42	25	27	4.15
15mL	50 PCS/Foam Rack	Conical	Yellow	CTF15YE	10 Racks (50 PCS/Rack, 10 Racks/Case)	44	38	29	4.95
25mL	25 PCS/Bag	Conical	Blue	CTB25BL	8 Bags (25 PCS/Bag, 8 Bags/Case)	42	35	20.5	2.50
25mL	25 PCS/Foam Rack	Conical	Blue	CTF25BL	8 Racks (25 PCS/Rack, 8 Racks/Case)	42	35	20.5	2.80
50mL	25 PCS/Bag	Conical	Yellow	CTB50YE	20 Bags (25 PCS/Bag, 20 Bags/Case)	60	40.5	27	7.70
50mL	25 PCS/Foam Rack	Conical	Yellow	CTF50YE	20 Racks (25 PCS/Rack, 20 Racks/Case)	42	34.5	63.5	8.50
50mL	25 PCS/Bag	Self-standing, Conical	Yellow	SCTB50YE	20 Bags (25 PCS/Bag, 20 Bags/Case)	52	48	29	8.45

Micro centrifuge tubes

- All micro centrifuge tubes are made of polypropylene.
- could work at centrifuge speed 25,000rpm.
- Flap caps are attached to open and close conveniently.
- Every tube has frosted writing area on the flat cap and the tube.
- Meanwhile, clear graduation on the tube for easier observation.
- All tubes are certified to be autoclavable at +121 C.

Maximum to
25,000
xg

cap lock

Series 1



More information about 5ml, please visit www.genfollower.com/5ml-micro-centrifuge-tube

Micro centrifuge tubes

with safe lock

LMTB005



0.5mL

LMTB020



2.0mL

LMTB015



1.5mL

LMTB050

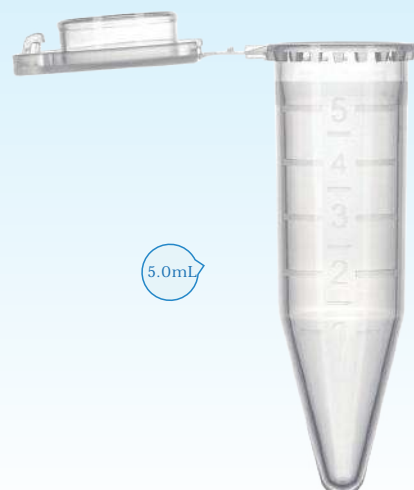

5.0mL



ORDER INFORMATION

Size	Color	Class	Packaging	Cat.#	Quantity per Case	Size / Case (CM)			Weight / Case (Kg)
						L	W	H	
0.5mL / 0.65mL	Nature	Common	1000 PCS/Bag	MCTB005	10 Bags (1000 PCS/Bag, 10 Bags/Case)	49	42	28.5	5.65
0.5mL / 0.65mL	Nature	Ultra Low retention	1000 PCS/Bag	MCTB005-R	10 Bags (1000 PCS/Bag, 10 Bags/Case)	49	42	28.5	5.65
0.5mL / 0.65mL	5 colors Mixed	Common	1000 PCS/Bag	MCTB005X	10 Bags (1000 PCS/Bag, 10 Bags/Case)	49	42	28.5	5.65
1.50mL / 1.60mL / 1.70mL	Nature	Common	500 PCS/Bag	MCTB015	10 Bags (500 PCS/Bag, 10 Bags/Case)	49.5	42	29	6.10
1.50mL / 1.60mL / 1.70mL	Nature	Ultra Low retention	500 PCS/Bag	MCTB015-R	10 Bags (500 PCS/Bag, 10 Bags/Case)	49.5	42	29	6.10
1.50mL / 1.60mL / 1.70mL	5 colors Mixed	Common	500 PCS/Bag	MCTB015X	10 Bags (500 PCS/Bag, 10 Bags/Case)	49.5	42	29	6.10
2.0mL	Nature	Common	500 PCS/Bag	MCTB020	10 Bags (500 PCS/Bag, 10 Bags/Case)	49.5	42	29	6.10
2.0mL	Nature	Ultra Low retention	500 PCS/Bag	MCTB020-R	10 Bags (500 PCS/Bag, 10 Bags/Case)	49.5	42	29	6.10
2.0mL	5 colors mixed	Common	500 PCS/Bag	MCTB020X	10 Bags (500 PCS/Bag, 10 Bags/Case)	49.5	42	29	6.10
5.0mL Best selling!	Nature	Common	200 PCS/Bag	MCTB050	10 Bags (200 PCS/Bag, 10 Bags/Case)	53.5	30.5	46.5	7.80
5.0mL	4 colors Mixed	Common	200 PCS/Bag	MCTB050X	10 Bags (200 PCS/Bag, 10 Bags/Case)	53.5	30.5	46.5	7.80

ORDER INFORMATION

Size	Color	Class	Packaging	Cat.#	Quantity per Case	Size / Case (CM)			Weight / Case (Kg)
						L	W	H	
0.5mL / 0.65mL	Nature	Common	1000 PCS/Bag	LMTB005	10 Bags (1000 PCS/Bag, 10 Bags/Case)	43	36	29	6.50
1.50mL / 1.60mL / 1.70mL	Nature	Common	500 PCS/Bag	LMTB015	10 Bags (500 PCS/Bag, 10 Bags/Case)	50	30.5	34	6.20
2.0mL	Nature	Common	500 PCS/Bag	LMTB020	10 Bags (500 PCS/Bag, 10 Bags/Case)	50	31	38.5	7.60
5.0mL	Nature	Common	300 PCS/Bag	LMTB050	15 Bags (300 PCS/Bag, 15 Bags/Case)	49.5	38	51	15.70

Cap Lock

Fit for	Color	Class	Packaging	Cat.#	Quantity per Case	Size / Case (CM)			Weight / Case (Kg)
						L	W	H	
For 1.50mL tube	Light blue	Common	25PCS/Bag	CL15	5000 PCS	42	42	24	4.10
For 5.0mL tube	Light blue	Common	25PCS/Bag	CL25	5000 PCS	52	37	38	5.70

Please kindly note other colors available if catalog number followed color code, YE = yellow, BL=blue, PK = pink, PU =purple, GR = green. It means MCTB015YE is yellow 1.5mL micro centrifuge tubes.

Racks for Tubes & Vials



121°C

· All racks are made of durable material. Could be autoclavable at 121°C, so they are reusable after clean or autoclave sterile.

RMCT2

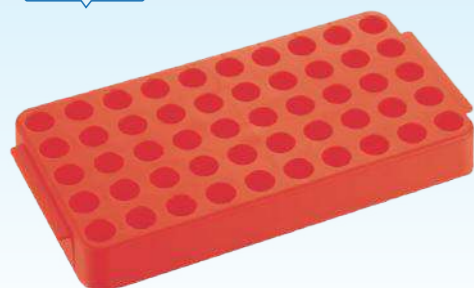

RMCT15

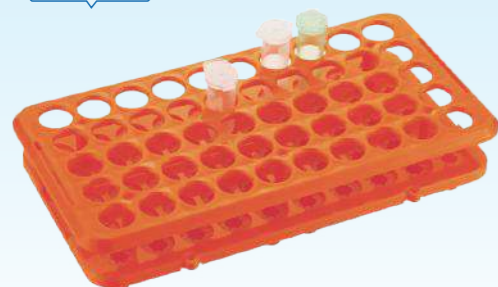

RTM0001



RTM0001

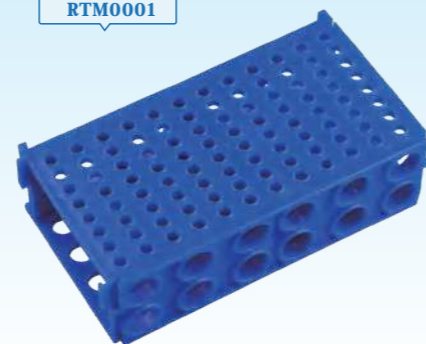

RTM0001

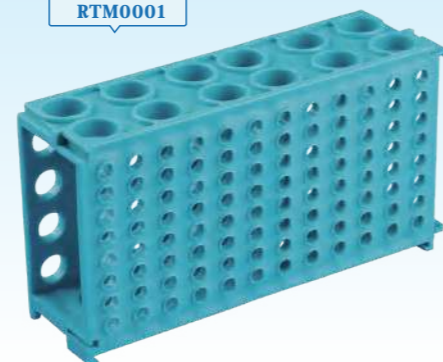

More racks will be available in future, please visit our websites.

ORDER INFORMATION

Size	Number of wells	Color	Packaging	Cat.#	Qty / Case	Size / Case (CM)			Weight / Case(kg)
						L	W	H	
1.5mL / 2.0mL	50	Orange	Individual	RMCT2	50 PCS	44	34	19.5	5.40
5.0mL / 15mL	50	Orange	Individual	RMCT15	50 PCS	64	53	25	12.00
0.2mL/2.0mL/15mL/50mL	96/32/12/4	Green/Blue/Purple	Individual	RTM0001	50 PCS	51	46	26.5	8.05

Petri dishes

- made of original quality PS.
- flat bottom for culture bacteria

True flat!



ORDER INFORMATION

Size (D X H)	Culture use	Material	Packaging	Cat.#	Quantity per Case	Size / Case (CM)			Weight / Case(Kg)
						L	W	H	
90 x 15mm	Bacterial	PS	10PCS/Bag	PD00009	20 Bags/Case (10PCS/Bag, 20 Bags/Case)	48	38.5	18	4.10

Screw Cap Culture Tubes

- Our patented screw cap design prevents liquid splashing and ensures safe centrifugation.
- The white writing area and flat cap provide a convenient space for clear marking and labeling.
- Clear graduations ensure precise liquid transfer.
- These tubes support both aerobic and anaerobic cultures.

STBP05, PP



5mL

STBP12, PP



12mL

STBS05, PS



5mL

STBS12, PS



12mL

ORDER INFORMATION

Capacity	Material	Packaging	Cat.#	Quantity per Case	Size / Case (CM)			Weight / Case (Kg)
					L	W	H	
5mL	PP	25 Tubes/Bag	STBP05	20 Bags/Case (25 Tubes/Bag, 20 Bags/Case)	31	20.5	20	2.00
5mL	PS	25 Tubes/Bag	STBS05	20 Bags/Case (25 Tubes/Bag, 20 Bags/Case)	31	20.5	20	2.05
5mL	PP	50 Tubes/Rack	STFP05	10 Racks/Case (50 Tubes/Rack, 10 Racks/Case)	31	28	20	2.05
5mL	PS	50 Tubes/Rack	STFS05	10 Racks/Case (50 Tubes/Rack, 10 Racks/Case)	31	28	20	2.10
12mL	PP	25 Tubes/Bag	STBP12	20 Bags/Case (25 Tubes/Bag, 20 Bags/Case)	37	25	28	4.00
12mL	PS	25 Tubes/Bag	STBS12	20 Bags/Case (25 Tubes/Bag, 20 Bags/Case)	37	25	28	4.05
12mL	PP	50 Tubes/Rack	STFP12	10 Racks/Case (50 Tubes/Rack, 10 Racks/Case)	41	36	25	4.40
12mL	PS	50 Tubes/Rack	STFS12	10 Racks/Case (50 Tubes/Rack, 10 Racks/Case)	41	36	25	4.45



Cell Scrapers, Blades & Lifters



Cell scrapers

- blades are made of special TPE the Blade could be adjusted to fit any angle in the petri dishes, helps researchers collect cells as more as possible.
- customized packaging is available.
- Rnase and DNase free, No Human DNA, endotoxin free.

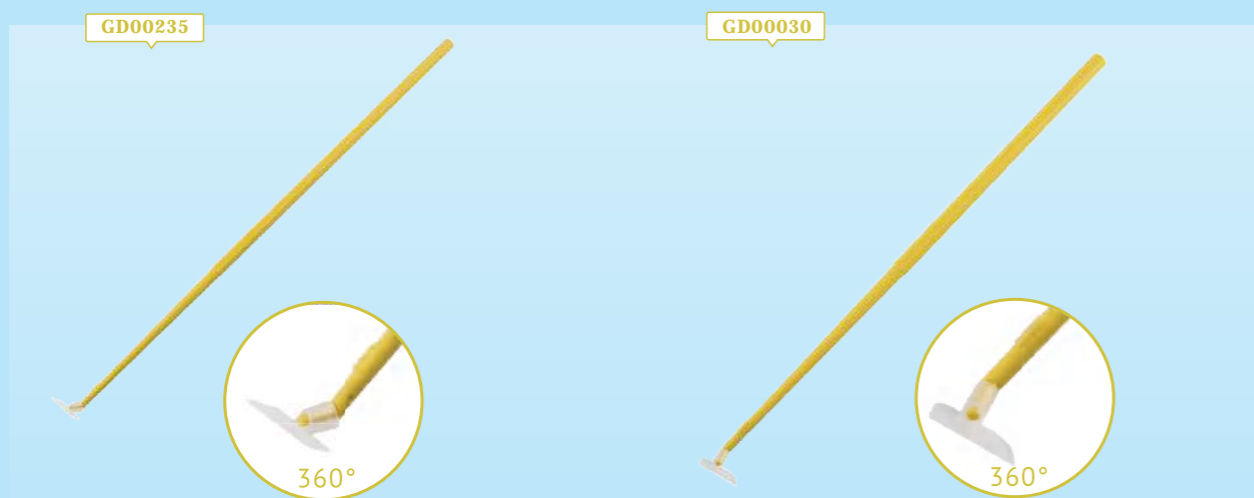

Cell Lifters

- made of quality PP clear and straight blades greatly avoid damage to cells during lifting.
- wider blade could increase efficiency, save precious time of researchers.
- the improved angle of blade could avoid crowd to cells during the operation.
- customized packaging is available.
- Rnase and DNase free, No Human DNA, endotoxin free.

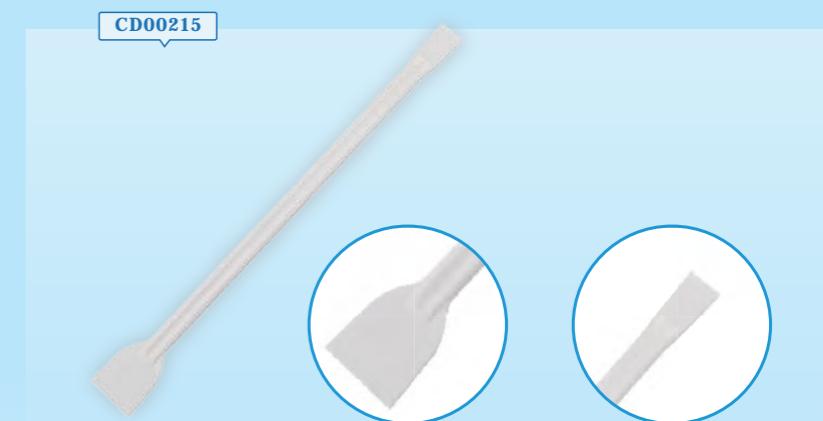
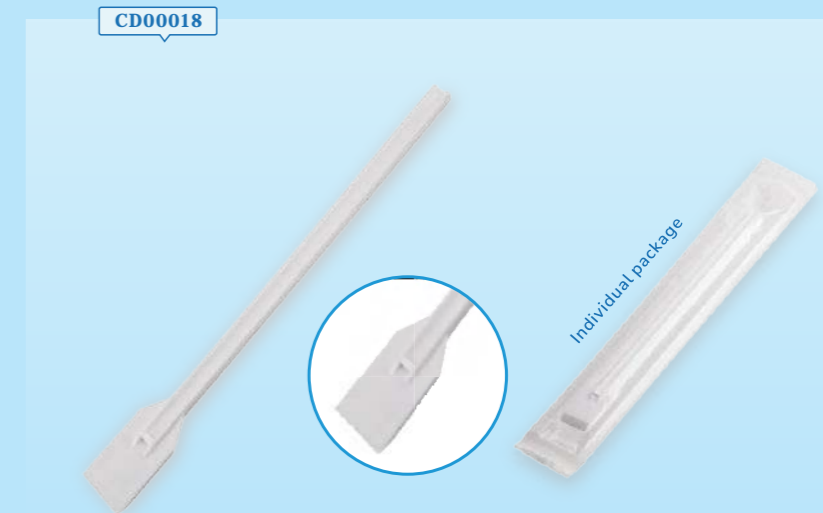

CELL SCRAPERS							Size / Case (CM)			Weight / Case(Kg)
Material	Total Length	Length of blade	Packaging	Cat. #	Quantity per Case	L	W	H		
handle is PP , blade is TPE	180mm	19mm	Individual	GD00018	400 PCS/Case (100 PCS/Bag, 4 Bags/Case)	37.5	32.5	19.5	2.85	
handle is PP , blade is TPE	250mm	19mm	Individual	GD00025	200PCS/Case (100 PCS/Bag, 2 Bags/Case)	38	31	16	2.60	
handle is PP , blade is TPE	235mm	13mm	Individual	GD00235	200PCS/Case (100 PCS/Bag, 2 Bags/Case)	39.5	28.5	24	2.05	
handle is PP , blade is TPE	300mm	20mm	Individual	GD00030	200PCS/Case (100 PCS/Bag, 2 Bags/Case)	38	31	16	2.98	

CELL LIFTERS						Size / Case (CM)			Weight / Case(Kg)
Type	Total Length	Length of blade	Packaging	Cat. #	Quantity per Case	L	W	H	
Single blade	180mm	18.5mm	Individual	CD00018	400PCS/Case (100 PCS/Bag, 4 Bags/Case)	50	41.5	16.5	4.20
Double blade	215mm	23mm and 12mm	Individual	CD00215	200PCS/Case (100 PCS/Bag, 2 Bags/Case)	38	31	16	2.70

Please kindly note Packaging quantity could be customized, such as 10PCS/Bag or 25 PCS/Bag. Please contact us if you have such different requirements.

Cell Spreaders

- 2 types of cell spreaders available: "L" and "T" shape.
- Both spreaders are made of quality HIPS.
- extremely smooth of the surface
- individual packaging, pre-sterilized, DNase free, RNase free, endotoxin free, No human DNA.

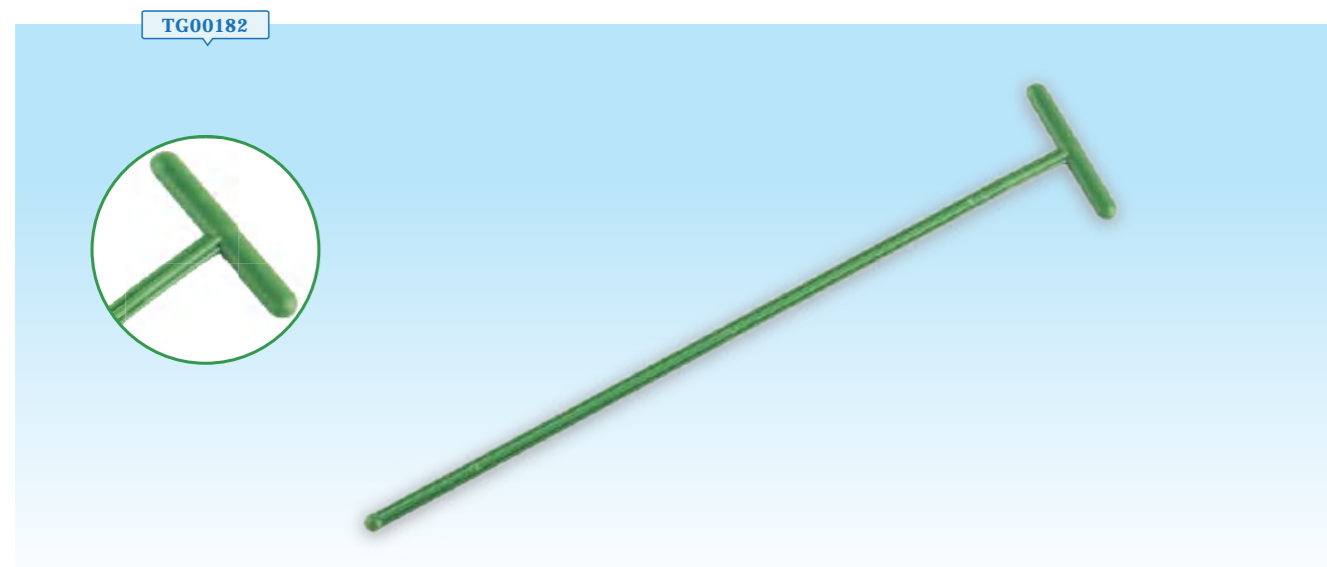

ORDER INFORMATION

Type	Total Length	Width for spread	Packaging	Cat.#	Quantity per Case	Size / Case (CM)			Weight / Case (Kg)
						L	W	H	
L shape	148mm	30mm	Individual	TG00148	2000PCS/Case (100 PCS/Bag, 20 Bags/Case)	50	30	36	8.80
T shape	182mm	32mm	Individual	TG00182	2000PCS/Case (100 PCS/Bag, 20 Bags/Case)	50	30	38	11.00

Please kindly note packaging quantity could be customized, such as 10PCS/Bag or 25 PCS/Bag. Please contact us if you have such different requirements.

Inoculating Loops & Needles

- made of HIPS.
- special smooth surface helps protect cells during operation.
- the handle is soft to fit different shape of containers.

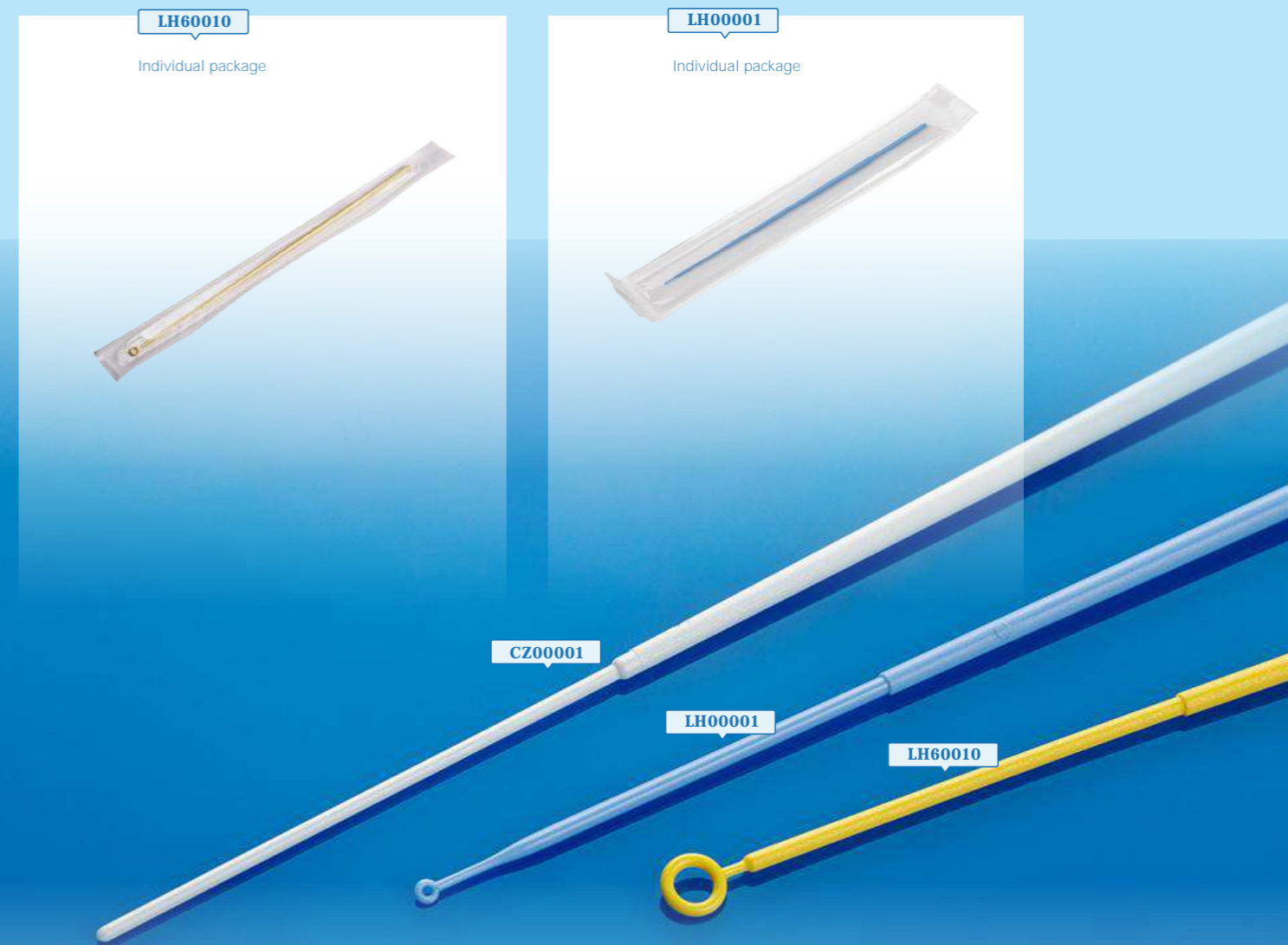

ORDER INFORMATION

Size	Total Length	Color	Packaging	Cat.#	Quantity per Case	Size / Case (CM)			Weight / Case (Kg)
						L	W	H	
Needle	228mm	White	Individual	CZ00001	500PCS/Case (10 PCS/Bag, 50 Bags/Case)	38	31	16	1.90
10µL	232mm	Yellow	Individual	LH60010	500PCS/Case (10 PCS/Bag, 50 Bags/Case)	38	31	16	1.90
1µL	218mm	Blue	Individual	LH00001	500PCS/Case (10 PCS/Bag, 50 Bags/Case)	38	31	16	1.90

Please kindly note packaging quantity could be customized, such as 10PCS/Bag or 25 PCS/Bag. Please contact us if you have such different requirements.

Serological pipettes

- Easily identified with color code
- Cotton plugged for safety
- Individual wrapped
- Optical-grade polystyrene(PS)
- 2 graduation mark
- Accruy: $\pm 2\%$
- sterile, non-Pyrogenic, free of DNA, DNase, RNase

YSPS01-1

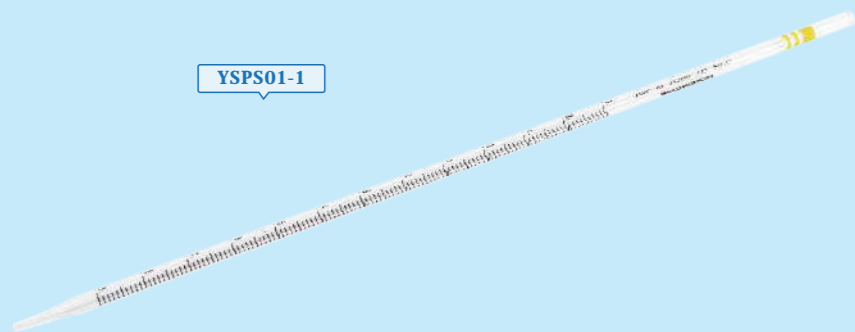

YSPS02-1

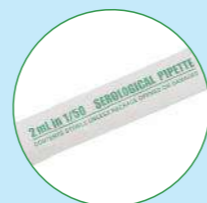
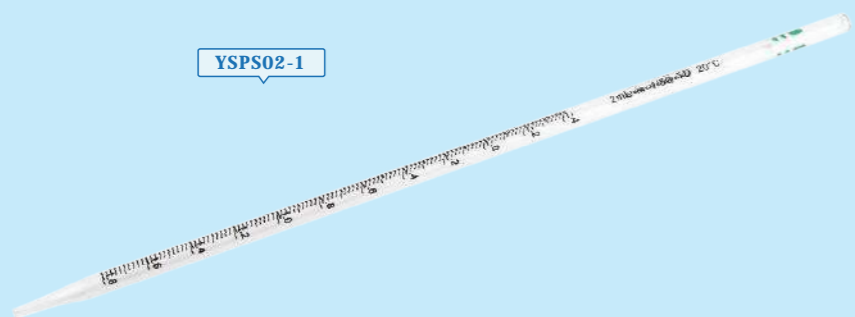

YSPS05-1



YSPS10-1

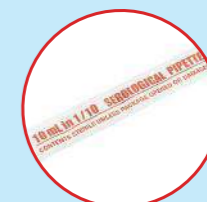
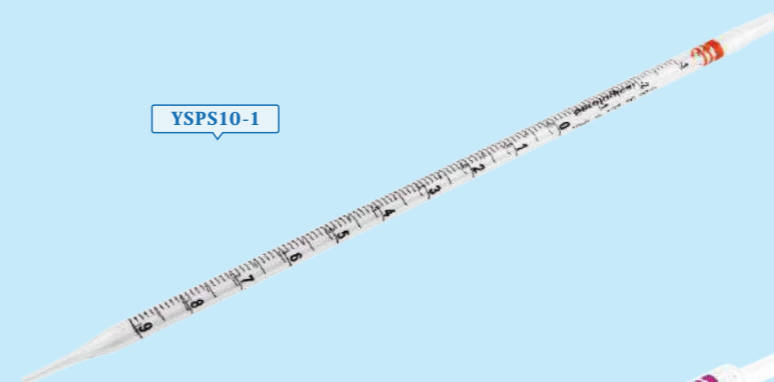

YSPS25-1

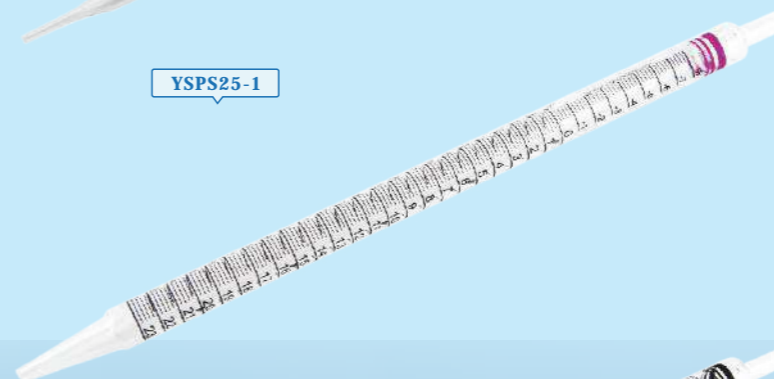

YSPS50-1

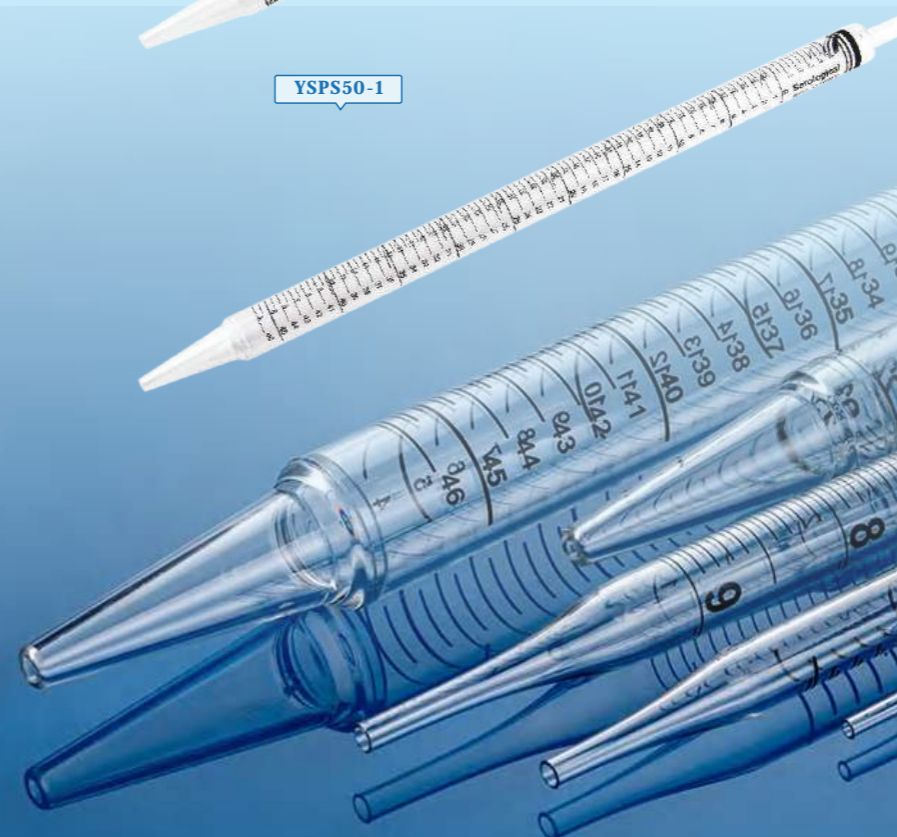

ORDER INFORMATION

Size	Packaging	Min. graduation	Color	Cat.#	Quantity per Case	Size / Case (CM)			Weight / Case(Kg)
						L	W	H	
1mL	300 PCS/Box	1/100mL	Yellow	YSPS01-1	6 Boxes (300 PCS/Box, 6 Boxes/Case)	60	37	40	11.85
2mL	300 PCS/Box	1/100mL	Green	YSPS02-1	6 Boxes (300 PCS/Box, 6 Boxes/Case)	60	37	40	13.40
5mL	200 PCS/Box	1/10mL	Blue	YSPS05-1	4 Boxes (200 PCS/Box, 6 Boxes/Case)	60	42	39	14.70
10mL	200 PCS/Box	1/10mL	Orange	YSPS10-1	4 Boxes (200 PCS/Box, 6 Boxes/Case)	60	42	39	17.25
25mL	100 PCS/Box	2/10mL	Purple	YSPS25-1	3 Boxes (100 PCS/Box, 6 Boxes/Case)	60	42	39	13.50
50mL	75 PCS/Box	5/10mL	Black	YSPS50-1	6 Boxes (75 PCS/Box, 6 Boxes/Case)	60	42	39	17.25

Pasteur pipettes

- made of High quality HDPE
- individual packaging available
- DNase and RNase free, endotoxin free, No human DNA.

Individual Packaging available!



ORDER INFORMATION

Max Graduation	Length	Material	Packaging	Cat.#	Quantity per Case	Size / Case (CM)			Weight / Case (kg)
						L	W	H	
1mL	159mm	LDPE	Individual	PT60001	2000PCS/Case (500 PCS/Box, 4 Boxes/Case)	49	41.5	35	4.90
1mL	159mm	LDPE	bulk	PT00001	5000PCS/Case (500 PCS/Box, 10 Boxes/Case)	80	31	45	10.50
3mL	162mm	LDPE	Individual	PT60003	2000PCS/Case (500 PCS/Box, 4 Boxes/Case)	49	41.5	35	5.20
3mL	162mm	LDPE	bulk	PT00003	5000PCS/Case (500 PCS/Box, 10 Boxes/Case)	80	31	45	10.50
3mL	160mm	LDPE	Individual	PT60033	2000PCS/Case (500 PCS/Box, 4 Boxes/Case)	49	41.5	35	5.20
3mL	160mm	LDPE	bulk	PT00033	5000PCS/Case (500 PCS/Box, 10 Boxes/Case)	80	31	45	10.50

Screw cap micro tubes



WG60008-T



0.5mL

WG60012-T



1.5mL

WG60016-T



2.0mL



amber color tubes are available

WG60098-T



0.5mL

WG60912-T



1.5mL

WG60916-T



2.0mL



amber color tubes are available

Series 1

Screw cap micro tubes

ORDER INFORMATION

Size	Sterile	Cap	Packaging	Cat.#	Quantity per Case	Size / Case (CM)			Weight / Case(Kg)
						L	W	H	
0.5mL	Yes	Screwed on	50 PCS/Bag	WG60008-T	20 Bags (50 PCS/Bag, 20 Bags/Case)	39	32	20	1.85
0.5mL	No	Not screwed on	500 PCS/Bag	WG00008-T	10 Bags (500 PCS/Bag, 10 Bags/Case)	50	30	40	9.30
0.5mL, Amber tube with Amber cap	Yes	Screwed on	50 PCS/Bag	WG60008AM-T	20 Bags (50 PCS/Bag, 20 Bags/Case)	39	32	20	1.85
0.5mL, Amber tube with Amber cap	No	Not screwed on	500 PCS/Bag	WG00008AM-T	10 Bags (500 PCS/Bag, 10 Bags/Case)	50	30	40	9.30
0.5mL	Yes	Attached cap, Screwed on	50 PCS/Bag	WG60098-T	20 Bags (50 PCS/Bag, 20 Bags/Case)	39	32	20	1.90
0.5mL	No	Attached cap, Not Screwed on	500 PCS/Bag	WG00098-T	10 Bags (500 PCS/Bag, 10 Bags/Case)	50	30	40	9.35
0.5mL, Amber tube with Amber cap	Yes	Attached cap, Screwed on	50 PCS/Bag	WG60098AM-T	20 Bags (50 PCS/Bag, 20 Bags/Case)	39	32	20	1.90
0.5mL, Amber tube with Amber cap	No	Attached cap, Not Screwed on	500 PCS/Bag	WG00098AM-T	10 Bags (500 PCS/Bag, 10 Bags/Case)	50	30	40	9.35
1.5mL	Yes	Screwed on	50 PCS/Bag	WG60012-T	20 Bags (50 PCS/Bag, 20 Bags/Case)	39	32	20	1.98
1.5mL	No	Not screwed on	500 PCS/Bag	WG00012-T	10 Bags (500 PCS/Bag, 10 Bags/Case)	50	30	40	10.02
1.5mL, Amber tube with Amber cap	Yes	Screwed on	50 PCS/Bag	WG60012AM-T	20 Bags (50 PCS/Bag, 20 Bags/Case)	39	32	20	1.98
1.5mL, Amber tube with Amber cap	No	Not screwed on	500 PCS/Bag	WG00012AM-T	10 Bags (500 PCS/Bag, 10 Bags/Case)	50	30	40	10.02
1.5mL	Yes	Attached cap, Screwed on	50 PCS/Bag	WG60912-T	20 Bags (50 PCS/Bag, 20 Bags/Case)	39	32	20	2.05
1.5mL	No	Attached cap, Not Screwed on	500 PCS/Bag	WG00912-T	10 Bags (500 PCS/Bag, 10 Bags/Case)	50	30	40	10.10
1.5mL, Amber tube with Amber cap	Yes	Attached cap, Screwed on	50 PCS/Bag	WG60912AM-T	20 Bags (50 PCS/Bag, 20 Bags/Case)	39	32	20	2.05
1.5mL, Amber tube with Amber cap	No	Attached cap, Not Screwed on	500 PCS/Bag	WG00912AM-T	10 Bags (500 PCS/Bag, 10 Bags/Case)	50	30	40	10.10
2.0mL	Yes	Screwed on	50 PCS/Bag	WG60016-T	20 Bags (50 PCS/Bag, 20 Bags/Case)	38	31	16	1.91
2.0mL	No	Not screwed on	500 PCS/Bag	WG00016-T	10 Bags (500 PCS/Bag, 10 Bags/Case)	50	30	40	9.82
2.0mL, Amber tube with Amber cap	Yes	Screwed on	50 PCS/Bag	WG60016AM-T	20 Bags (50 PCS/Bag, 20 Bags/Case)	38	31	16	1.91
2.0mL, Amber tube with Amber cap	No	Not screwed on	500 PCS/Bag	WG00016AM-T	10 Bags (500 PCS/Bag, 10 Bags/Case)	50	30	40	9.82
2.0mL	Yes	Attached cap, Screwed on	50 PCS/Bag	WG60916-T	20 Bags (50 PCS/Bag, 20 Bags/Case)	38	31	16	1.95
2.0mL	No	Attached cap, Not Screwed on	500 PCS/Bag	WG00916-T	10 Bags (500 PCS/Bag, 10 Bags/Case)	50	30	40	9.85
2.0mL, Amber tube with Amber cap	Yes	Attached cap, Screwed on	50 PCS/Bag	WG60916AM-T	20 Bags (50 PCS/Bag, 20 Bags/Case)	38	31	16	1.95
2.0mL, Amber tube with Amber cap	No	Attached cap, Not Screwed on	500 PCS/Bag	WG00916AM-T	10 Bags (500 PCS/Bag, 10 Bags/Case)	50	30	40	9.85



Please kindly note caps still other colors available, YE = yellow, BL=blue, PK = pink, PU = purple, AM = amber, please add color code after the catalog number, for example, YE for yellow, when followed color cod, it's WG00007YE"

Screw cap micro tubes

higher cap for easier screwing



ORDER INFORMATION

Type	Sterile	Cap	Packaging	Cat.#	Quantity per Case	Size / Case (CM)			Weight / Case(Kg)
						L	W	H	
0.5/0.65/0.7mL, separate cap	Yes	Screwed on the tube	50 PCS/Bag	WG60007	20 Bags	38	31	16	1.40
0.5/0.65/0.7mL, separate cap	No	Not screwed on	500 PCS/Bag	WG60007	10 Bags	50	30	40	7.00
0.5/0.65/0.7/0.8mL, self-standing, separate cap	Yes	Screwed on the tube	50 PCS/Bag	WG60008	20 Bags	38	31	16	2.52
0.5/0.65/0.7/0.8mL, self-standing, separate cap	No	Not screwed on	500 PCS/Bag	WG60008	10 Bags	50	30	40	10.60
1.0/1.2/1.5mL, separate cap	Yes	Screwed on the tube	50 PCS/Bag	WG60010	20 Bags	38	31	16	1.80
1.0/1.2/1.5mL, separate cap	No	Not screwed on	500 PCS/Bag	WG60010	10 Bags	50	30	40	8.60
1.0/1.2/1.5mL self-standing, separate cap	Yes	Screwed on the tube	50 PCS/Bag	WG60012	20 Bags	38	31	16	2.60
1.0/1.2/1.5mL, self-standing, separate cap	No	Not screwed on	500 PCS/Bag	WG60012	10 Bags	50	30	40	11.00
1.5/1.6/1.7/2.0mL, separate cap	Yes	Screwed on the tube	50 PCS/Bag	WG60014	20 Bags	38	31	16	2.50
1.5/1.6/1.7/2.0mL, separate cap	No	Not screwed on	500 PCS/Bag	WG60014	10 Bags	50	30	40	10.50
1.5/1.6/1.7/2.0mL, self-standing, separate cap	Yes	Screwed on the tube	50 PCS/Bag	WG60016	20 Bags	38	31	16	2.60
1.5/1.6/1.7/2.0mL, self-standing, separate cap	No	Not screwed on	500 PCS/Bag	WG60016	10 Bags	50	30	40	11.00

Please kindly note caps still other colors available, YE = yellow, BL=blue, PK = pink, PU = purple, AM = amber, please add color code after the catalog number, for example, YE for yellow, when followed color cod, it's WG00007YE"

Screw cap micro tubes

Series 3



ORDER INFORMATION

Size	Sterile	Cap	Packaging	Cat.#	Quantity per Case	Size / Case (CM)			Weight / Case(kg)
						L	W	H	
0.5mL, self-standing, separate cap	Yes	Screwed on	50 PCS/Bag	WG60005	20 Bags (50 PCS/Bag, 20 Bags/Case)	39	32	20	1.85
2.0mL, self-standing, separate cap	Yes	Screwed on	50 PCS/Bag	WG60020	20 Bags (50 PCS/Bag, 20 Bags/Case)	38	31	16	1.91

Please kindly note caps still other colors available, YE = yellow, BL=blue, PK = pink, PU = purple, AM = amber, please add color code after the catalog number, for example, YE for yellow, when followed color cod, it's WG00007YE*

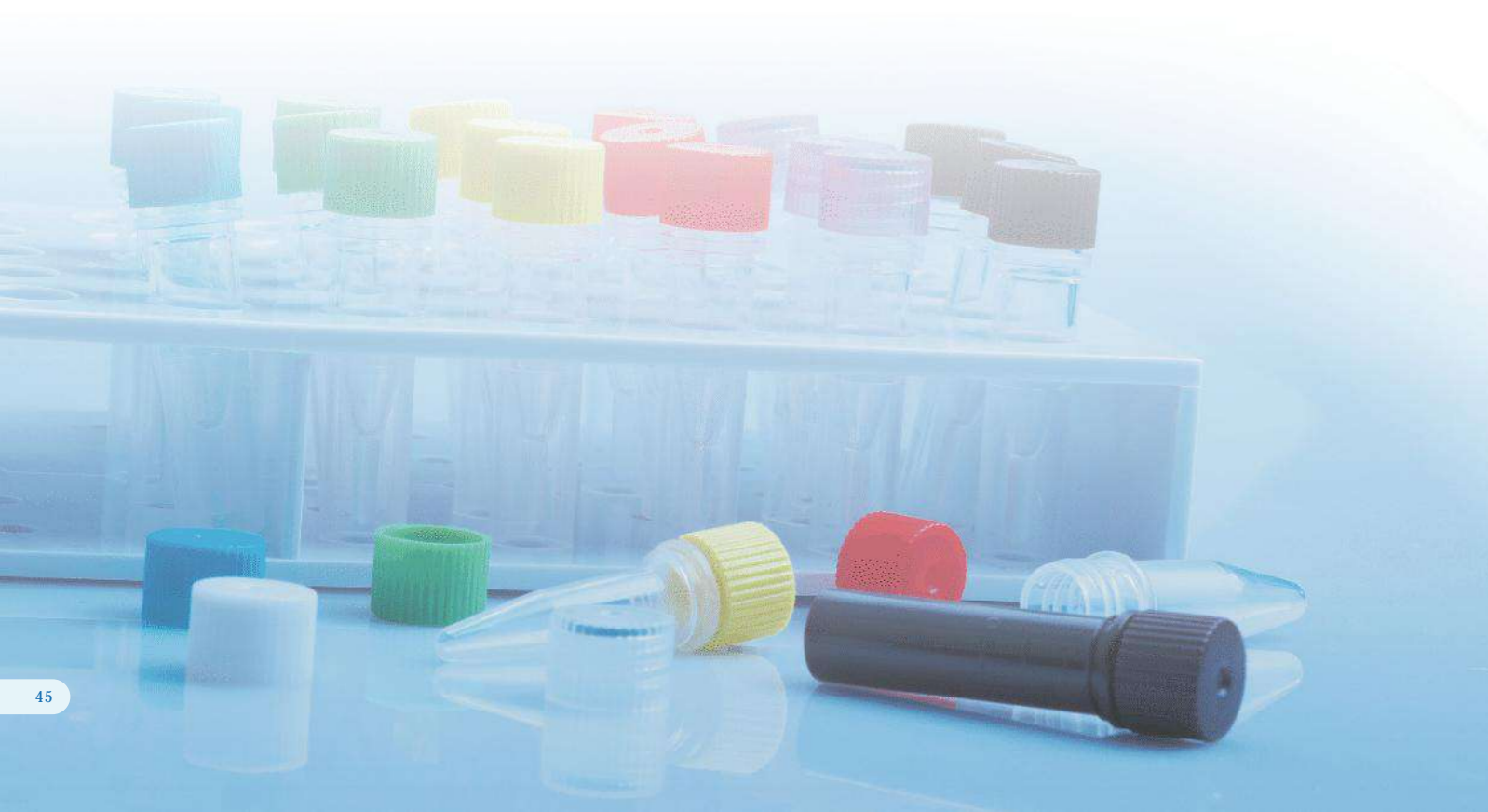

Cryo tubes

- caps with silicon seal-ring ensures a positive leakproof seal
- 2 types available: self-standing and U bottom.
- PCR purity: DNase and RNase free, No Human DNA, endoxin free.

External threads

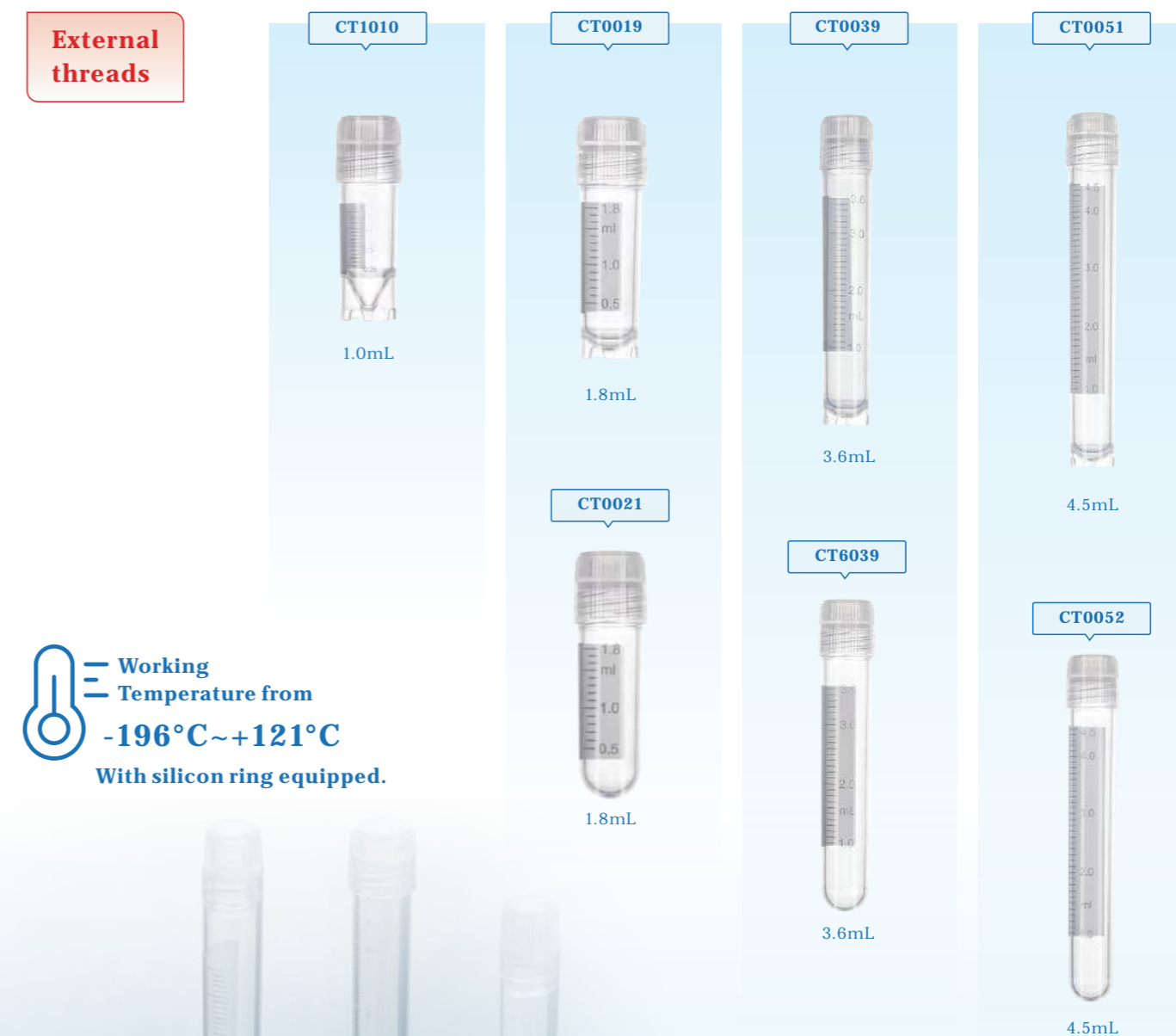

Working Temperature from **-196°C~+121°C**
With silicon ring equipped.

colorful cap inserts are available

Cryo tubes

Working Temperature from **-196°C ~ +121°C** With silicon ring equipped.

External threads

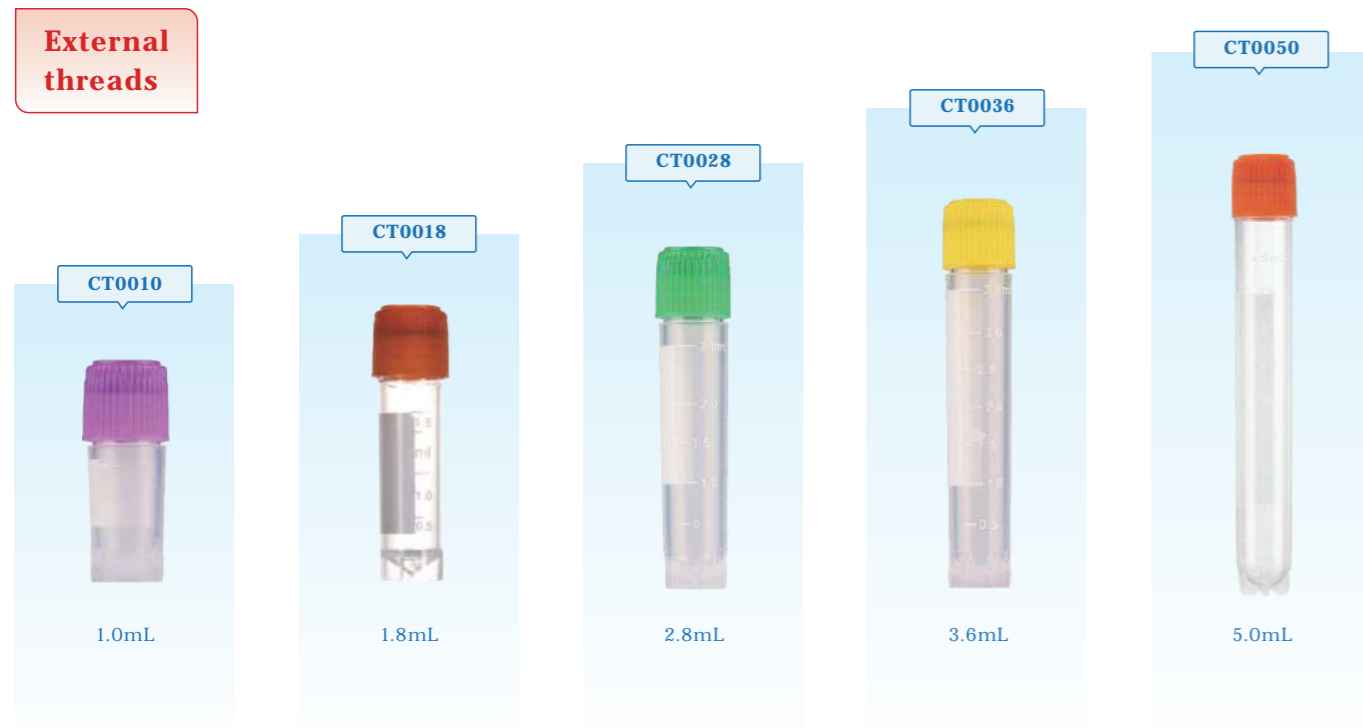

External threads-01

Size & type	Cap Type	Max Graduation	Packaging	Cat.#	Quantity per Case	Size / Case (CM)			Weight / Case(kg)
						L	W	H	
1.0mL/1.2mL, self-standing	External threads	1.0mL	50 PCS/Bag	CT1010	20 Bags (50 PCS/Bag, 20 Bags/Case)	38	31	16	1.80
1.8mL/2.0mL, self-standing	External threads	1.8mL	50 PCS/Bag	CT0019	20 Bags (50 PCS/Bag, 20 Bags/Case)	38	31	16	2.40
1.8mL/2.0mL, U-bottom	External threads	1.8mL	50 PCS/Bag	CT0021	20 Bags (50 PCS/Bag, 20 Bags/Case)	38	31	16	2.20
3.6mL/3.8mL, self-standing	External threads	3.6mL	50 PCS/Bag	CT0039	20 Bags (50 PCS/Bag, 20 Bags/Case)	38	31	16	3.60
3.6mL/3.8mL, U-bottom	External threads	3.6mL	50 PCS/Bag	CT6039	20 Bags (50 PCS/Bag, 20 Bags/Case)	38	31	16	3.40
4.5mL/5.0mL, self-standing	External threads	4.5mL	50 PCS/Bag	CT0051	20 Bags (50 PCS/Bag, 20 Bags/Case)	39	28	24	4.10
4.5mL/5.0mL, U-bottom	External threads	4.5mL	50 PCS/Bag	CT0052	20 Bags (50 PCS/Bag, 20 Bags/Case)	39	28	24	3.95

External threads-02

Size & type	Cap Type	Max Graduation	Packaging	Cat.#	Quantity per Case	Size / Case (CM)			Weight / Case(kg)
						L	W	H	
1.0mL/1.2mL, self-standing	External threads	1.0mL	50 PCS/Bag	CT0010	20 Bags (50 PCS/Bag, 20 Bags/Case)	38	31	16	1.80
1.8mL/2.0mL, self-standing	External threads	1.8mL	50 PCS/Bag	CT0018	20 Bags (50 PCS/Bag, 20 Bags/Case)	38	31	16	2.40
2.8mL/3.0mL, self-standing	External threads	2.8mL	50 PCS/Bag	CT0028	20 Bags (50 PCS/Bag, 20 Bags/Case)	39	28	24	2.80
3.6mL/3.8mL, self-standing	External threads	3.6mL	50 PCS/Bag	CT0036	20 Bags (50 PCS/Bag, 20 Bags/Case)	39	28	24	3.50
4.5mL/5.0mL, self-standing	External threads	4.5mL	50 PCS/Bag	CT0050	20 Bags (50 PCS/Bag, 20 Bags/Case)	39	28	24	4.10

Cryo tubes

- caps with silicon seal-ring ensures a positive leakproof seal
- 2 types available: self-standing and U bottom.
- PCR purity: DNase and RNase free, No Human DNA, endoxin free.

Internal threads

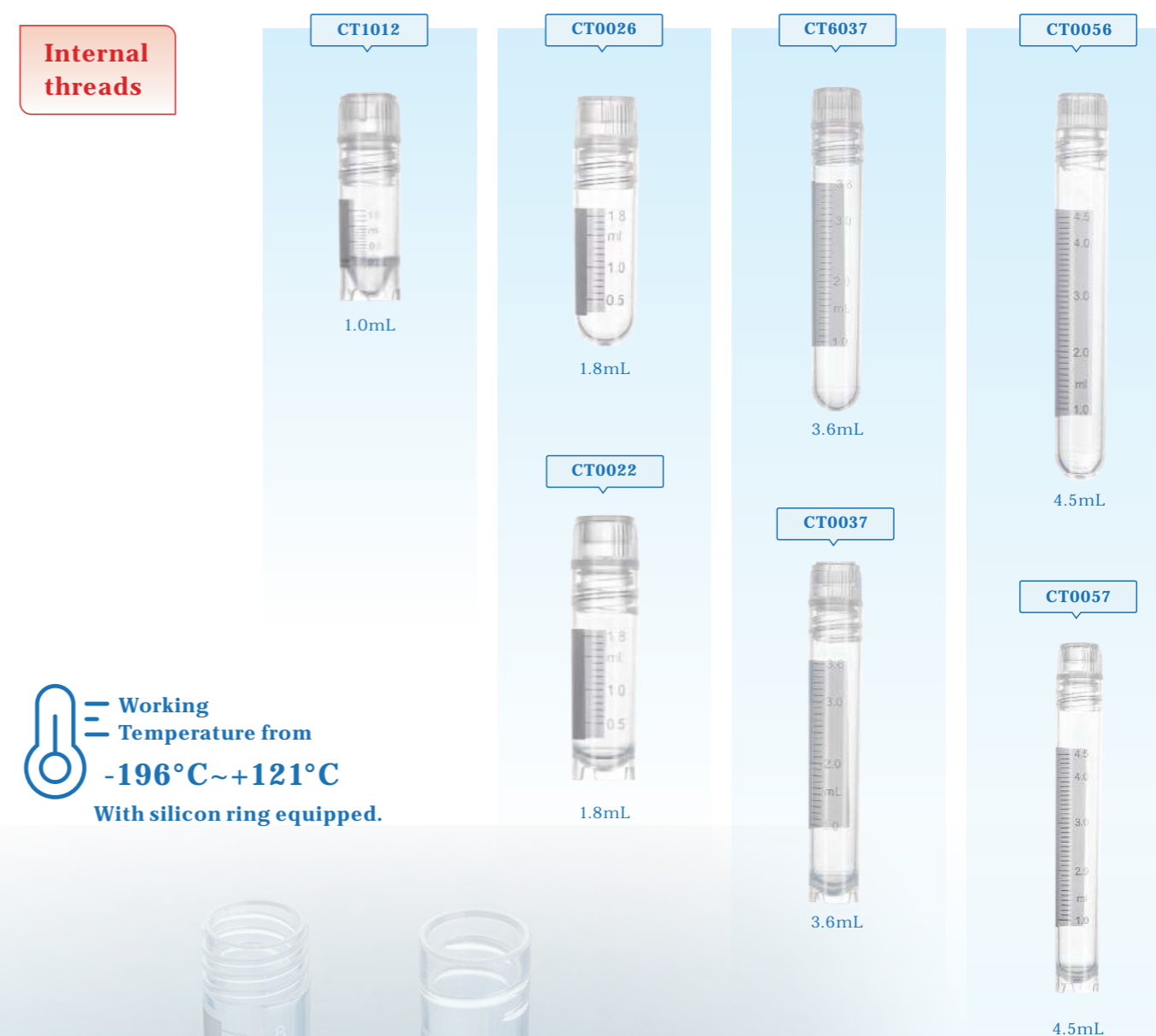

Working Temperature from **-196°C ~ +121°C** With silicon ring equipped.



Cryo tubes

Working Temperature from **-196°C ~ +121°C** With silicon ring equipped.

Internal threads

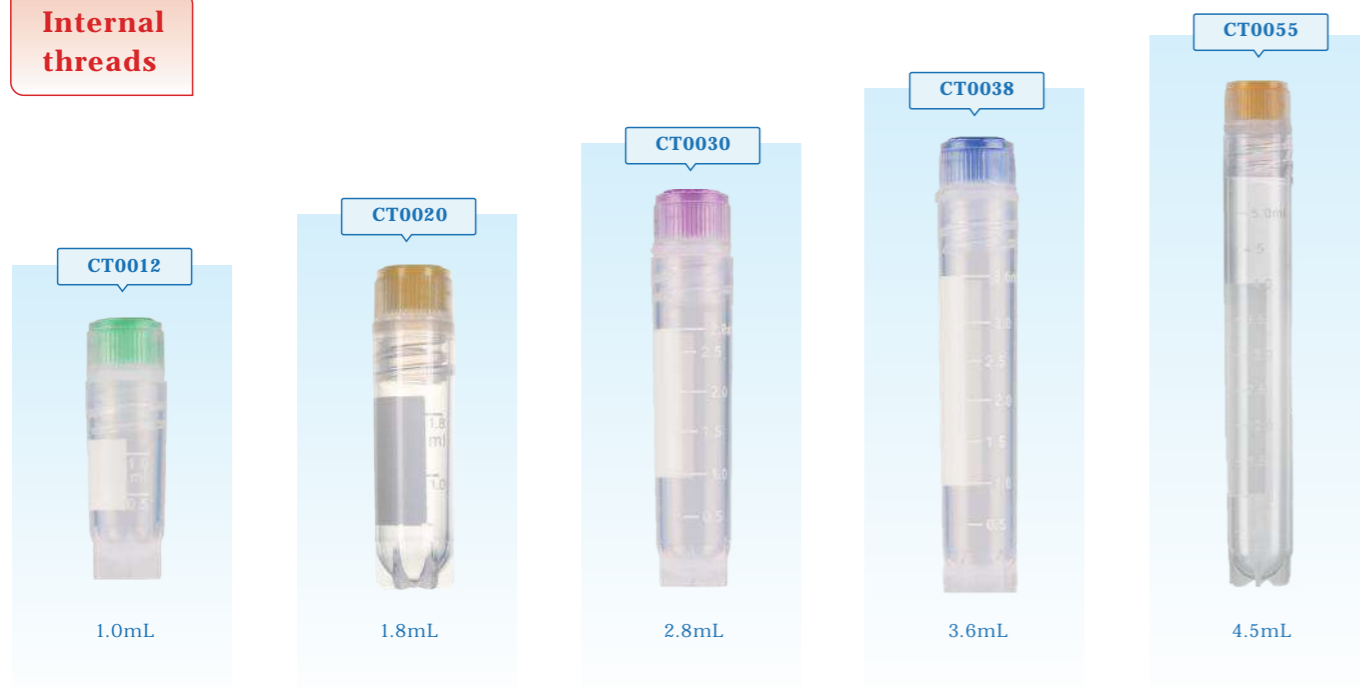

Internal threads-01

Size & type	Cap Type	Max Graduation	Packaging	Cat.#	Quantity per Case	Size / Case (CM)			Weight / Case(kg)
						L	W	H	
1.0mL/1.2mL, self-standing	Internal threads	1.0mL	50 PCS/Bag	CT1012	20 Bags (50 PCS/Bag, 20 Bags/Case)	38	31	16	1.80
1.8mL/2.0mL, self-standing	Internal threads	1.8mL	50 PCS/Bag	CT0022	20 Bags (50 PCS/Bag, 20 Bags/Case)	38	31	16	2.40
1.8mL/2.0mL, U-bottom	Internal threads	1.8mL	50 PCS/Bag	CT0026	20 Bags (50 PCS/Bag, 20 Bags/Case)	38	31	16	2.20
3.6mL/3.8mL, self-standing	Internal threads	3.6mL	50 PCS/Bag	CT0037	20 Bags (50 PCS/Bag, 20 Bags/Case)	38	31	16	3.60
3.6mL/3.8mL, U-bottom	Internal threads	3.6mL	50 PCS/Bag	CT6037	20 Bags (50 PCS/Bag, 20 Bags/Case)	38	31	16	3.40
5.0mL, self-standing	Internal threads	4.5mL	50 PCS/Bag	CT0057	20 Bags (50 PCS/Bag, 20 Bags/Case)	39	28	24	4.10
5.0mL, U-bottom	Internal threads	4.5mL	50 PCS/Bag	CT0056	20 Bags (50 PCS/Bag, 20 Bags/Case)	39	28	24	3.95

Internal threads-02

Size & type	Cap Type	Max Graduation	Packaging	Cat.#	Quantity per Case	Size / Case (CM)			Weight / Case(kg)
						L	W	H	
1.2mL, self-standing	Internal threads	1.0mL	50 PCS/Bag	CT0012	20 Bags (50 PCS/Bag, 20 Bags/Case)	38	31	16	1.80
2.0mL, self-standing	Internal threads	1.8mL	50 PCS/Bag	CT0020	20 Bags (50 PCS/Bag, 20 Bags/Case)	38	31	16	2.40
2.8mL/3.0mL, self-standing	Internal threads	2.8mL	50 PCS/Bag	CT0030	20 Bags (50 PCS/Bag, 20 Bags/Case)	39	28	24	2.80
3.6mL/3.8mL, self-standing	Internal threads	3.6mL	50 PCS/Bag	CT0038	20 Bags (50 PCS/Bag, 20 Bags/Case)	39	28	24	3.50
5.0mL, self-standing	Internal threads	4.5mL	50 PCS/Bag	CT0055	20 Bags (50 PCS/Bag, 20 Bags/Case)	39	28	24	4.10

Please kindly note The colored cap-inserts are also available, please add color code PU, YE, BL and etc. For CT0020 iwith yellow cap-insert, it's CT0020YE. If purchase cap-inserts individually, please use Catalog number CT0000, if Yellow one, then CT0000YE.

Cryo racks

· made of polycarbonate · working temperature could be down to **-196°C**.

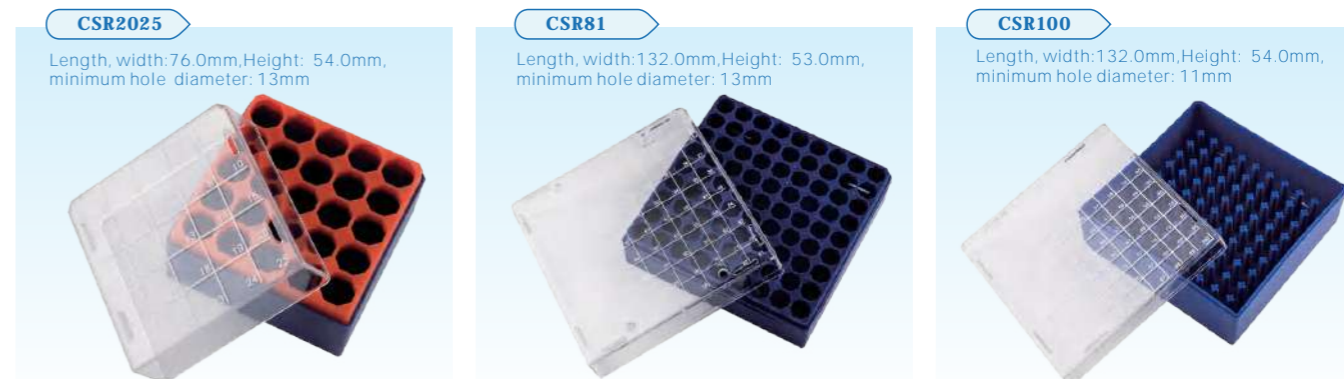

ORDER INFORMATION

Size	Material	Number of Wells	Packaging	Cat.#	Quantity per Case	Size / Case (CM)			Weight / Case(kg)
						L	W	H	
1.50mL / 2.0mL	PC	25	Individual	CSR2025	100 PCS/Case	41	41	27.5	8.40
1.50mL / 2.0mL	PC	81	Individual	CSR81	50 PCS/Case	52	37	30	7.90
1.50mL / 2.0mL	PC	100	Individual	CSR100	50 PCS/Case	69.5	28.5	28.5	10.70

Spin Columns

All spin columns produced in class 100,000 clean room, DNase and RNase free, endotoxin free, no human DNA.



ORDER INFORMATION

Material of filter	Levels	Color of ring	Packaging	Cat.#	Quantity per Case	Size / Case (CM)			Weight / Case(kg)
						L	W	H	
Silicon	4	None	100 PCS/Bag	CS40004	10 Bags (100 PCS/Bag, 10 Bags/Case)	38	31	16	1.80
Silicon	6	None	100 PCS/Bag	CS60006	10 Bags (100 PCS/Bag, 10 Bags/Case)	38	31	16	1.80
Silicon	8	None	100 PCS/Bag	CS80008	10 Bags (100 PCS/Bag, 10 Bags/Case)	38	31	16	1.80

Please kindly note Catalog number contain spin columns and collection tubes together.

Liquid Handling Workstation

· Liquid Handling Workstation is a better solution for high-throughput manual pipetting with two ranges of 0.5~20 μ L (M20) and 5~200 μ L (M200), which have been applied in many fields, such as template copying, transferring between 96-well plates and 384-well plates, orifice cleaning, dilution and ELISA / EIA.

reduce pipetting steps effectively

- >less than 6 seconds to complete one time of 96-well plate pipetting by hand.
- >only 4 steps for 384-well plate with 2 times within 1 minute.

Increase your data accuracy

- >start or stop the enzymatic reaction or cell experiments at the same time
- >eliminates the difference between well to well.
- >improves the reproducibility from well to well and from plate to plate
- >never skips or repeats pipetting.

Easy and safe to use

- >provide a ultra-fast pipetting with no programming, no plug-in and no training.

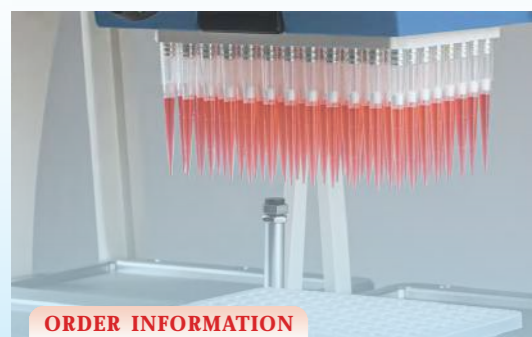

ORDER INFORMATION

Product Name	Volume Range	Structure	Packaging	Cat. #	Size / Case (CM)			Weight / Case(Kg)	MOQ
					L	W	H		
Liquid Handling Workstation	0.5-20 L	Desktop	1 PC / Case	M20	63	50	70	30.10	1 PC
	5-200 L	Desktop	1 PC / Case	M200	63	50	70	30.10	1 PC

Dry Bath incubator

· The GMB-0215 digital dry bath heaters are outstanding products with broad temperature range and accurate control, which also have a patent in preventing from scald.

· The digital panel of our products is easy and quick to operate, which gives life science researchers the convenience and the efficiency they need when working with precious samples.



ORDER INFORMATION

Product Name	Capacity Size	Structure	Packaging	Cat. #	Size / Case (CM)			Weight / Case(Kg)	MOQ
					L	W	H		
Dry Bath Incubator	0.2/1.5/2.0/5.0mL tube	Desktop	1 PC / Case	GMB0215	33	27	18	5.40	1 PC

Have a patent in anti-scald

- >When the block temperature reach to 150°C, the temperature of the panel and the body are below 50°C.

Wide temperature range

- >temperature can reach to 150°C

Rapid heating time

- >finish heating within 15min

3 steps of programs preset

- >Preset programs can be changed and combined as you like.

Digital touchable keyboard & Full screen

Mini Dry Bath incubator

· MDB-05F is a hand-held thermostatic dry bath controlled by a microcomputer, and it is featured as its most advantage, super fast heating up. The instruments with small size and light weight are specially designed for use in crowded experimental bench.

Super fast heating up

>It only takes about 5-6 minutes to rise from room temperature to 100°C

Small size, compact and lightweight

>one hand can hold the device

High appearance

>One-piece magnesium shell

Safe and secure

>overheating protection
>over-temperature power-off



ORDER INFORMATION

Product Name	Capacity Size	Structure	Packaging	Cat.#	Size / Case (CM)			Weight / Case(Kg)	MOQ
					L	W	H		
Mini Dry Bath	5.0mL tube	Desktop	1 PC / Case	MDB-05F	23	13	16	1.67	1 PC

Mini Microcentrifuge

· Genfollower Mini-Centrifuges are flexible and cost effective, allowing any workstation to be equipped with a "personal" mini centrifuge. Humanized preset timing function design enables the instrument to carry out one-click timing. The instruments are equipped with mixed rotor and a variety of tube sleeves, available for 2.0ml, 1.5ml, 0.5ml and 0.2ml centrifuge tubes.

Speed maximum up to 10,000 rpm

> Adjusted speed maximum up to 10,000 rpm, freely switchable to meet different experimental requirements

Humanized time preset

>3 sets of common time preset : 3s, 10s, 30s

Safe to use

> When over 6,000 rpm, the lid will be in a buffer before fully open, waiting for the high-speed rotating rotor to slow down for safety
> Electromagnetic switch: Close the lid to start and open to stop

Designed with the composite rotor

>suitable for 6x0.5/1.5/2.0ml centrifuge tubes and 2x8x0.2ml PCR tube strips

Compact and lightweight



ORDER INFORMATION

Product Name	Rotor	Structure	Packaging	Cat.#	Size / Case (CM)			Weight / Case(Kg)	MOQ
					L	W	H		
Mini Microcentrifuge	6x0.5/1.5/2.0mL tube, 2x8x0.2mL PCR strip	Portable	1 PC / Case	GSC-10K	32	26	24	2.30	1 PC



Microplate Centrifuge

· C-MP2 is an instantaneous centrifuge specially designed for microplates, which is convenient to quickly spins down droplets. Equipped with a dual-position vertical rotor, it accepts a wide variety of PCR plates, including 96-well plates, 384-well plates, skirted plates and non skirted plates.

A variety of PCR plates available

>Accept skirted, non-skirted and all standard PCR plates

Quickly spin down droplets in PCR plates

>Set hot key "Short" for quick and convenient spinning

Adjustable speed

>maximum speed can reach 3000rpm

Touchable screen displayed

>LED screen and touchable



ORDER INFORMATION

Product Name	Rotor	Structure	Packaging	Cat. #	Size / Case (CM)			Weight / Case (Kg)	MOQ
					L	W	H		
Microplate Centrifuge	2 PCR plates	Desktop	1 PC / Case	C-MP2	33	30	30	5.10	1 PC

Mini Vortex Mixer

· Mini vortex mixer is an ideal vortex mixer with its tiny size and easy-to-use, and it is designed for oscillating and blending of various reagents, solutions, chemicals and other samples. Simply push the tube into the soft attachment to start shaking. It is used for mixing samples in small containers (maximum 50mL centrifuge tube) and has the function of inching.

Simple operation

>Push the tube into the soft attachment to start shaking, and stops when tube lifted.

Small size, compact and lightweight

>one hand can hold the device

Two modes are available for choosing

>Pulsing mode for short time mixing sample (inching)
>Continuous mode (long time continuous operation)

A variety of containers available

>maximum 50ml centrifuge tube

Adjustable speed

>maximum speed can reach 4500rpm

Portable

>Support car cigarette lighter to convert power supply



ORDER INFORMATION

Product Name	Capacity Size	Structure	Packaging	Cat. #	Size / Case (CM)			Weight / Case (Kg)	MOQ
					L	W	H		
Mini Vortex Mixer	maximum 50mL tube	Portable	1 PC / Case	MI-45	17	17	21	1.20	1 PC

Multi-tube Vortex Mixer

· MM-5015 multi-tube vortex mixer is used to prepare samples by mixing tubes just prior to testing with compact and simple in appearance. It can maximum mix 50 samples at the same time. Variety of accessories are also available to be selected to meet the mixing needs with different specifications of test tubes. Built-in continuous mode and pulse mode enable the instruments suitable for biotechnology, microbiology and medical analysis.

Built-in timing function

- >Able to be set mixing time within 00:00~99:59h
- >The display window shows the remnant time to do timing

Two modes are available for choosing

- >Pulse mode
- >Continuous mode

Make the experiment more efficient

- >Maximum 50 samples mixing at the same time

Adjustable speed

- >Ranging from 500 rpm – 2500 rpm

Different types of foam tube racks and pads to replace

- >Support a variety of consumables

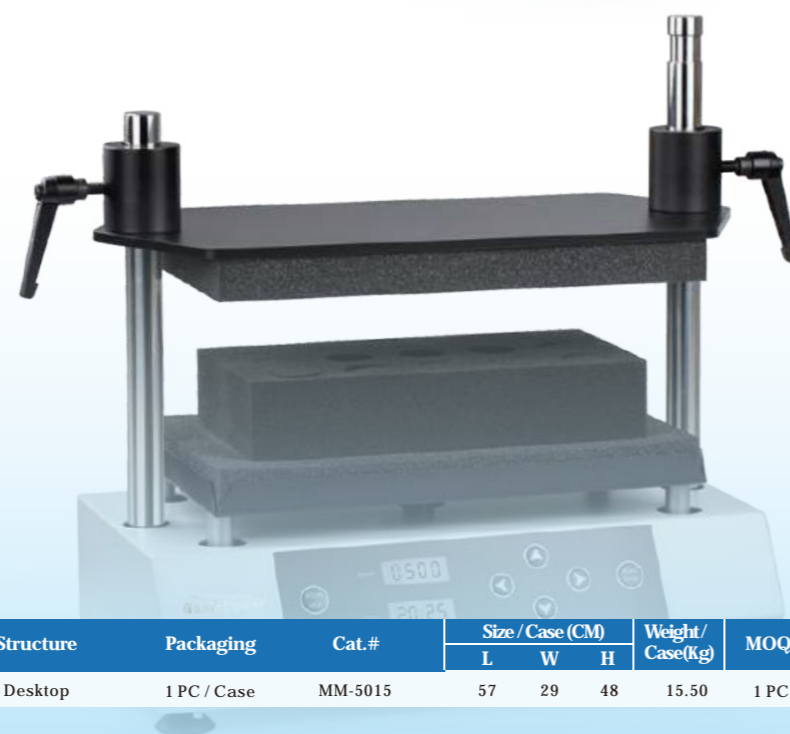

ORDER INFORMATION

Product Name	Capacity Size	Structure	Packaging	Cat. #	Size / Case (CM)			Weight / Case (Kg)	MOQ
					L	W	H		
Multi-tube Vortex Mixer	Different Foams Available	Desktop	1 PC / Case	MM-5015	57	29	48	15.50	1 PC

Vertical Rotating Mixer

· MM-V5016 Vertical Rotating Mixer provides efficient but gentle mixing to keep the sample in suspension status. With its adjustable speed, the rotating mixer is widely used in blood mixing, preventing blood clots, latex diagnosis, immunoprecipitation and similar applications. Equipped with a large-size color LCD screen and adopted full touch operation mode, the instrument can quickly input time, speed and other parameters, which meets the researchers' needs for modernization of bench-top instruments.

Large size screen to display

- >Color LCD screen and adopt full touch operation mode

Optional different tube holder frames available

- >Including but not limited to 16 x 50 mL and 16 x 15 mL centrifuge tubes

Smooth and steady operation

- >360° vertical circulation rotation

Intelligent and efficient

- >Controlled by microprocessor and allow 5 programs to run in sequence



ORDER INFORMATION

Product Name	Capacity Size	Structure	Packaging	Cat. #	Size / Case (CM)			Weight / Case (Kg)	MOQ
					L	W	H		
Vertical Rotating Mixer	15mL and 50mL tube	Desktop	1 PC / Case	MM-V5016	60	26	24	5.10	1 PC

Mobile Thermostatic Boxes

· The patented MOBOX is a full temperature thermostat with optional lithium ion battery. The temperature control stability is $\pm 0.1^{\circ}\text{C}$, and the control range is $0-70^{\circ}\text{C}$. It has excellent performance in the application of constant temperature reaction, sample transferring, anatomy and incubation, and is loved by the majority of scientific research workers.

Temperature stability $\pm 0.1^{\circ}\text{C}$

Temperature control accuracy $\pm 0.3^{\circ}\text{C}$

Multifunction in wide application

>Ice box, sample incubation platform, dissection table and heating reactor

Optional lithium-ion battery

>Work last for 4-5 hours at constant temperature 25°C ;
>Work last for 1-2 hours in large temperature difference between the sample and the outside

Mobile

>Easy to carry for sample transferring when you go out

Support on-board power supply

>No worries if the battery runs out



ORDER INFORMATION

Product Name	Modules	Structure	Packaging	Cat. #	Size / Case (CM)			Weight / Case (Kg)	MOQ
					L	W	H		
Mobile Thermostatic Box	Free combination	Portable	1 PC / Case	DC-MO1	32	30	30	5.50	1 PC

Blu-ray Gel Cutting Apparatus

· UV-C108 is a lightweight replacement of the traditional UV transmission instrument, applied in clearly observing and cutting the nucleic acid in the dyeing gel. The machine adopts world-class LED blue light source with long life, and creatively adds adjustable light intensity function to ensure the moderate brightness of the strip to the maximum extent, helping to protect your eyes and take a clear picture of the experimental results.

>Blue light protects users from exposure to uv damage but no damage for DNA fragments.

>The selected optical grade shortwave cut-off filter can filter blue light efficiently, making the background of the gel picture clean and easy to observe

>Selected wear-resistant and scratch-resistant bottom plate

>The brightness can be adjusted by the brightness adjustment knob

>Exquisite and Compact Design and easy to carry

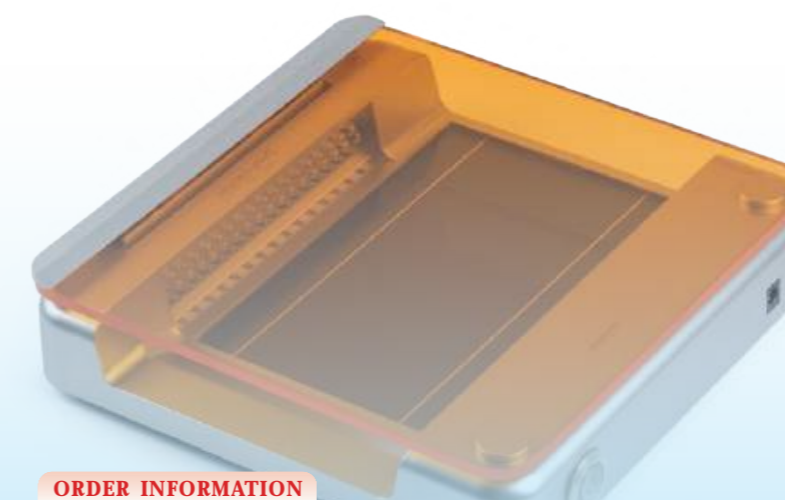

ORDER INFORMATION

Product Name	Maximum gel size	Structure	Packaging	Cat. #	Size / Case (CM)			Weight / Case (Kg)	MOQ
					L	W	H		
Blu-ray Gel Cutting Apparatus	100mm x 150mm	Desktop	1 PC / Case	UV-C108	34	28	11	1.80	1 PC

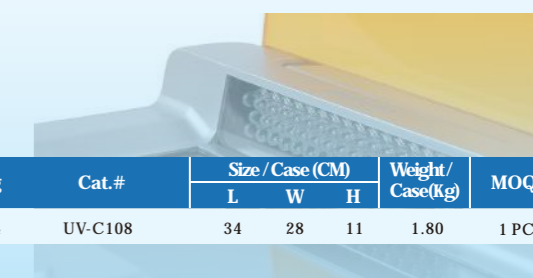

Infrared Sterilizer

· Infrared Sterilizer uses infrared heat sterilization, widely applied in biosafety cabinets, purification workbenches, suction fans, and mobile vehicles. This instrument provides two temperature options for you, high to 825°C and low at 480°C, to completely sterilize instruments only in 5-7 seconds. The ceramic heating element is safely enclosed in a perforated stainless steel guard chamber, protecting users from accidental contact with the extreme temperatures of the core area. Besides, it is highly compact, convenient, and can be used in anaerobic and aerobic chambers.

Safe and reliable

>No open flame, no fear of wind and suitable for low oxygen environment

Two temperature options

>Provide two temperature to select, 480°C and 825°C

Suitable for sterilization of medical apparatus

>Widely used in sterilization of inoculation ring, inoculation needle, tweezers and scissors

Convenient

>Sterilization and disinfection only in 5-7s



ORDER INFORMATION

Product Name	Largest diameter	Structure	Packaging	Cat. #	Size / Case (CM)			Weight / Case(Kg)	MOQ
					L	W	H		
Infrared Sterilizer	φ 14 mm	Desktop	1 PC / Case	HW-800L	33	28	20	1.64	1 PC
	φ 35 mm	Desktop	1 PC / Case	HW-800S	33	28	20	1.78	1 PC